

Glendale

PARADESTORE.COM

NEW DRONES!
An exciting way to learn and build new skills.
See page 2



AGSU Uniforms *NEW!*
Visit Paradestore.com for full selection

SAVE on Flags —
new lower prices
See pages 95-99

ROTC and JROTC
Rank and Insignia
see page 59

 Contract GS-03F-048BA
Advantage!

 Contract 670-22

Contract SP47W121D0005
FEDMALL 

Everything You Need to Be Parade-Ready

Quick Index

See full index on page 79

Arc Pins	69
Ascots	44
Belts	33-35
Berets	42-43
Bib Scarves • Leader Loops	44
Books • DVDs	14
Cheater Bars	39
Custom Flags/Banners/Patches	92-93
DrillAmerica® Rifles	4-10
Fire / Rescue	50
Flag Carriers	82-84
Flag Covers and Cases	85
Flag Pole Floor Stands	86-87
Flag Pole Ornaments	88-89
Flag Poles	90-91
Flags	94-99
Garment & Gear Bags	46-47
Gloves	20-22
Hat Carriers	66-67
MarchOn® Tee Shirts	online
Medals and Drapes	74-78
Memorial	51-55
Nameplates	41
Ordering Information	80-81
Parade Helmets	45
Parade Rifles	4-10, 14
Pins: Hat • Collar • Lapel	51, 60-63, 68-69
Police Hats	48
PT Clothing and Tee Shirts	32
Ribbon Attachments	56, 70
Ribbon Mounts	70-71
Ribbon Slides	56, 61-62, 72-73, 75
Rifle and Pistol Accessories	11-15, 34-37
ROTC & JROTC	56-62
Saber & Sword Accessories	19
Sabers & Swords	16-17
Shoe & Boot Accessories	38-39
Shoes	39
Shoulder Cords	23-31
Uniform Accessories	40-41
U.S. Air Force	65-67
U.S. Army	64
U.S. Marine Corps	63

Made in USA with pride

Glendale proudly carries a huge selection of products made right here, stateside. We strive to source our products from manufacturers within the USA. Look for the logo above, which denotes that the product was made in America.

Our Quality Pledge

Glendale fully guarantees all merchandise against defects in material and workmanship.

Glendale assumes no liability for any loss, damage, injury or expense of any kind arising out of the use or abuse of products in this catalog. This catalog may not be reproduced in whole or in part without the written consent of Glendale.

© Copyright 2024 Glendale Parade Store, LLC..

codrone^{EDU}

A drone made for learning



Help Their Skills Soar!

JROTC Drones **NEW!**

Skilled drone pilots are coveted by the military, and the uses for drones are literally just taking off. Glendale has proudly partnered with CoDrone to offer this best-in-class drone to help you teach your JROTC students piloting, programming and communication skills and/or prepare them for JROTC drone flying competitions. Includes quick-start guide, extra propellers, 8 landing pads, smart controller, rechargeable batteries and charger. American Security Drone Act (Section 889) compliant and ready to fly.

Single Drone #DR100 \$314.99 each

Competition CoDrone EDU JROTC Edition Classroom Package **NEW!**

20 drones, 20 power packs, 2 frames, 2 controllers, 2 motors, 4 hr PD and two year extended warrantee.

Set of 20 #DR200 \$7,999.99 set



Drones come with everything you need including extra landing pads and replacement propellers.

Drones teach kids piloting, programming and communication skills.



We have everything Honor Guards and Color Guards need!



9' x 1 1/4" Gold Parade Pole #94G

9' x 1 1/4" Silver Parade Pole #94S

Telescoping Gold Parade Pole #94TG

Military 8' Guidon Pole #G87B

Flag and Guidon Poles

Whether you are looking for sturdy and lightweight aluminium poles, traditional wood poles or the classic guidon poles, Glendale has you covered. Turn to page 90 to see our full selection starting at \$62.95



#1802WH

Single and Double Harness Leather Flag Carriers

Comfortable and sturdy, in sizes and styles for every unit. Starting at \$39.95 Turn to page 82-84 to see our complete selection.



Heavy Weight, Black #174

Heavy Weight Pistol Belts

Starting at \$21.25 Turn to pages 33-34 to see the complete selection.



Imprinted Canvas Flag Covers

Keep your colors clean and secure. Starting at \$45.95 Turn to page 85 to learn more.

U.S. Flags: Indoor & Parade Use

Starting at \$64.95 Turn to page 99 to see our full selection of U.S. flags. Turn to page 95 for state flags. Call for a quote on custom colors.



No Fringe



Flag Pole Ornaments

29 to choose from, find yours on page 88. Starting at \$27.95

Level of customer service is why JROTC units around the country consistently turn to Glendale Parade Store for their uniform and equipment needs.

W West, AK

DrillAmerica® 1903 Springfield Replica Rifle

Beauty, balance, and authentic tone.

With the look, the feel and even the sound of the revered 1903 Springfield rifle, this highly detailed replica will take your drill team, honor guard or color guard to the next level. Known for both its beauty and balance, the 1903 Springfield is the functional equivalent of the drill rifles issued to each service, but with better balance, durability, and quality! Our DrillAmerica® 1903 Springfield is 43.3" long, weighs in at 8.5-8.6 lbs., and is made of the same tough, scratch-resistant high-impact resin as our DrillAmerica® M1 Garand.

What sets our DrillAmerica® 1903 Springfield Replica Rifle apart:

- Better balance: Bolt and 24" barrel are one continuous piece, distributing weight across the rifle for exceptional balance.
- Exceptional sound: The multi-component rifle has a bit of a tone when you slap or spin it and just enough give when you catch it. You'll appreciate its moving bolt for Inspection Arms.
- Superior durability: We went back to the 1903 original to capture the untouchable strength and toughness of its rear end swivel.
- More authentic look: The beautifully detailed appearance, the serialized bolt, and the black metal parts (also available in chrome) mirror the look of the 1903 original.
- Additional options: Vulcanized butt plate and sling sold separately (accepts any Glendale sling except the MK1 Parade Rifle Strap)

Introduce your team to the 1903 Springfield today and experience for yourself its precise center balance and outstanding sound.

DrillAmerica® 1903 Springfield Replica Rifle

Wood Grain Rifle Stock

DrillAmerica® 1903 Springfield Replica Rifle black metal	#DA1903	\$279.95 each
DrillAmerica® 1903 Springfield Replica Rifle chrome metal	#DA1903C	\$324.95 each

Black Rifle Stock

DrillAmerica® 1903 Springfield Replica Rifle black metal	#DA1903BK	\$274.95 each
DrillAmerica® 1903 Springfield Replica Rifle chrome metal	#DA1903BKC	\$319.95 each

White Rifle Stock

DrillAmerica® 1903 Springfield Replica Rifle chrome metal	#DA1903WHC	\$324.95 each
---	------------	----------------------

DrillAmerica® 1903 Springfield Butt Plate

To protect floors during indoor drills, replace the existing plate of your DA1903 with this metal plate covered with 1 cm of molded rubber.

Black Butt Plate	#DAS25	\$14.95 each
------------------	--------	---------------------

Brown Touch-up Marker

Cover up minor dings to keep your wood grain rifle looking presentable.

Touch-up Marker	#9130	\$2.95 each
-----------------	-------	--------------------

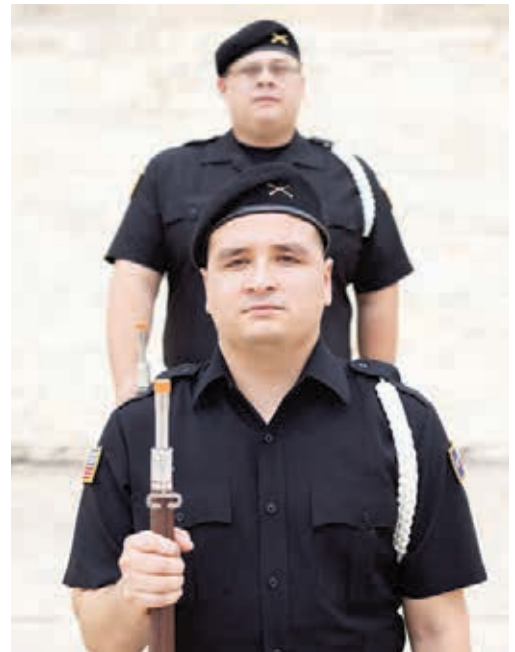

Isaac Rodriguez and Trey Simmonds of San Antonio, Gold Medalists in Tandem drill at World Drill Championships

Moving bolt



Glendale has a variety of slings, from sturdy web slings to premium quality, top grain leather slings. Turn to page 11 for more information.



Black with Nickel #202N

Classic rear end swivel is strong and built to last

**Need parts?
See page 13**

DrillAmerica® Makes the Best Drill Rifles You Can Buy!



DrillAmerica 1903
Springfield Rifle®
Black with Black Metal
#DA1903BK

Authentic tone

High-impact resin

5 MODELS!



Wood Grain
with Chrome
Metal
#DA1903C

Wood Grain
with Black
Metal
#DA1903

Black with
Chrome Metal
#DA1903BKC

White with Chrome
Metal
#DA1903WHC

DrillAmerica® M1 Garand Replica Rifle

Exceptional balance and quality

The overwhelming choice of drill teams, honor guards and color guards. The M1 Garand features a solid barrel which provides balance and durability. The front and rear swivels are reinforced and more durable than ordinary drill rifles so the M1 Garands can take anything you throw, (or spin) at them. Weighs 9 lbs. Features include a moving bolt to enable Inspection Arms, a trigger that "clicks" for effect, a reversible black rubber butt pad and a metal butt plate. Made of high-impact plastic with a wood-grain appearance, exterior chromed metal parts and a solid barrel. Approved for all JROTC competitions as a demilitarized weapon. Does not have bayonet lug. Length 43". Accepts any Glendale web or leather sling (not included).

All bolts can be engraved on one line, 24 characters maximum. We present the DrillAmerica® M1 Garand with pride. Use it wisely and well!

DrillAmerica® M1 Garand Rifle

Rifle with Moving Bolt	#M1000	\$199.95 each
Rifle engraved Moving Bolt	#M1000E	\$214.95 each

FREE shipping on orders over \$600

“This rifle continues to amaze me. I would not let my cadets use any other rifle except this one.”

CSM Randall Woods, Smith Cotton HS

It's Your Rifle, Put Your Name On It!

It's easy to make your rifle stand out from the crowd. The bolt of the MK1 can be engraved with up to 25 letters for just \$15. Please add 5 days for delivery.



Includes moving bolt

Each rifle has a reversible black butt pad and a metal butt plate

Trigger that "clicks" for effect

Reinforced Swivels

Our best selling Heavy Web Rifle Slings are sold on page 11



Exceptional in Every Respect

*First regulation weight,
center balanced, drill rifle in
the United States*

Solid Barrel

DrillAmerica Rifle®
#M1000

*High-impact plastic
with a wood-grain
appearance*

Rifle Stock only #1000S

Moving Bolt #1000MB

Safety Bolt #1000SB



City of
Takoma Park, MD
Police Honor Guard

DrillAmerica® M1 Garand Rifle Stock

Suitable for practice drill or as a replacement stock for previous model #1000 (screw holes included). Measures 36". Weight 8.5 lbs.

Rifle Stock #1000S **\$74.95** each

DrillAmerica® M1 Garand Rifle Accessories:

Bolts can be engraved, 24 characters maximum.

Submit customized engraving in writing.

DrillAmerica® M1 Garand Moving Bolt

Moving Bolt #1000MB **\$40.95** each

Moving Bolt with engraving #1000MBE **\$55.95** each

DrillAmerica® M1 Garand Safety Bolt without Handle

Completely interchangeable with Moving Bolt.

Safety Bolt #1000SB **\$31.95** each

Safety Bolt with engraving #1000SBE **\$46.95** each

Brown Touch-up Marker

Cover up minor dings to keep your rifle looking presentable.

Touch-up Marker #9130 **\$2.95** each

Replacement parts for the DrillAmerica® Rifle are available online at www.paradestore.com

Please Note:

Rifles are NOT RETURNABLE.

Before ordering a quantity of rifles, we suggest ordering a single piece for your examination to be certain it meets your requirements.

Rifles Cannot Be Guaranteed Against Breakage.

You will spin them, throw them, pound them and drop them. Our DrillAmerica® Rifles are built really tough, and while we can't guarantee you won't break them, it won't be easy.



“My cadets love their MK1 rifles more than any we’ve used in the past. From their durability and showmanship, they are the perfect style and weight for my cadets.”

Miriam Gaytan, Instructor,
TC Marsh Middle School LCC

Solid front band

Black MK1
#MK1BK

DrillAmerica® MK1 Replica Rifle

DrillAmerica® makes the best drill rifle you can buy. Period!

When you’re competing, you need enough mass to spin and enough sass to win. The MK1 rifle is weightier, sturdier, and, frankly, classier than other Mark 1’s—and easy on the wallet! Molded from high-impact resin for greater durability, the MK1 uses chrome-plated, non-moving parts and borrows its sturdy, durable metal front band and hardware from our most expensive rifles. 39” Long and roughly 4.3 pounds, which makes it a superior drill rifle for spinning. Can be fitted with any of our leather or cotton web slings.

Cast metal front band and hardware

DrillAmerica® MK1 Replica Rifle

Black Rifle	#MK1BK	\$87.95 each
Brown Rifle	#MK1BW	\$87.95 each
White Rifle	#MK1WH	\$87.95 each
White Practice Stock	#1001S	\$38.95 each

FREE shipping on orders over \$600

Non-moving plastic bolt and trigger

Brown MK1
#MK1BW

White MK1
#MK1WH

White Practice Stock
#1001S

MK1 Parade Rifle Strap

Designed for show, this Parade Rifle Strap is a shorter version of our Leather Rifle Slings (page 11).

Can be used as a replacement strap for MK1 and MK1 Masters Level replica rifles only.

Black leather	#1008BK	\$24.95 each
White leather	#1008WH	\$24.95 each



Scan this QR code with your phone or mobile device to shop, and see this rifle in action, or visit <https://glendale.com/drillamerica-mk1-replica-rifle/>.

(Despite concerted effort, no rifles were harmed making this video.)



DrillAmerica® MK1 and Masters Level MK1 Replica Rifles

MK1 Masters Level Replica Rifle

MK1 Masters Level Replica Rifle

An emerging legend in precision performance

"Back in the day", explained Michael M. Anderson, 1SG, USA (Ret.) and leader of the perennial champion Heights High School "Rough Riders" from Houston, Texas, "the Mark 1 Drill Rifle we had been using suffered from a number of deficiencies. They were underweighted, fragile and the quality was inconsistent. Our drill team went through stacks of them every year. That all changed when we met Joe Rivas from the Glendale Parade Store."

1SG Anderson told Joe that the MK1 needed some upgrades to earn the loyalty of people who spin heavy weapons. Joe listened and went to work with a respected drill rifle manufacturer. Here's what they did.

Heavier, more durable construction -

The MK1 Masters Level weighs 5.5 lbs. (a full pound heavier than our standard MK1). The stock is made from high impact resin to add weight and be nearly indestructible.

Full heavyweight barrel - The addition of a full-length metal barrel adds heft and improves the rifle's balance, so it makes spinning effortless.

The result? "We were so impressed with these rifles that we entered competitions using the prototypes that Joe sent us. The fact that we did says all you need to know about how great these rifles are. I placed an order for our whole team as soon as they were available."

Non-functioning all metal bolt assembly

Solid front band

Black MK1
#MAS1BK

Solid steel hardware

5.5 pounds, with more heft and better balance

Brown MK1
#MAS1BW

White MK1
#MAS1WH

DrillAmerica® Masters Level MK1 Replica Rifle

DrillAmerica® MK1 Masters Level Replica Rifle

Spin circles around the competition! Our Masters Level MK1 was designed to meet the needs of championship drillers. A solid longer barrel, metal receiver, and bolt assembly add a pound of heft that makes the balance exceptional and spinning effortless. You'll feel the difference the first time you put it through its paces. Accepts any of our leather or cotton web slings. 5.5 lbs, 41". Colors: Black. Brown. White.

DrillAmerica® MK1 Replica Rifle

Black MK1 Masters	#MAS1BK	\$106.95 each
Brown MK1 Masters	#MAS1BW	\$106.95 each
White MK1 Masters	#MAS1WH	\$106.95 each

FREE shipping on orders over \$600

Email customerservice@glendale.com • Order online at www.glendale.com

Full Size, Half the Weight 100% DrillAmerica®!

Building a Reliable Parade Rifle, One Test at a Time

Drill America® is more than a name, it is your guarantee that each rifle is the best you can buy. When we developed the Drill America DA30 Parade Rifle we made sure that it would deliver the consistency of weight and appearance that alternative arms drillers need to train effectively. Our high-impact resin parade rifle passed all of our quality tests—but we knew who the real experts were. We sent our rifles out to schools to be field-tested by numerous drill teams. Reports from the field helped us make a good rifle even better. Drillers told us to eliminate the front-stacking swivel and lower the screw-head profile to reduce risk of cuts. They asked us to improve the stiffness of the bolt spring so it wears better. Our testers told us what they wanted. We listened. And together we created a reliable drill-tested rifle perfect for practice and parades.

*Durable
Resin Stock*

DrillAmerica DA30
Parade Rifle®
#DA30BK

\$56.95
includes Sling!

*Includes web
rifle sling*

*Includes
moving bolt*

*Trigger that
“clicks” for effect*

*Rubber
Butt Plate*

*Sturdy
rear end swivel*

Please Note:

Rifles are NOT RETURNABLE. Before ordering a quantity of rifles, we suggest ordering a single piece for your examination to be certain it meets your requirements. **Rifles Cannot Be Guaranteed Against Breakage.** You will spin them, throw them, pound them and drop them. Our DrillAmerica Rifles are built really tough, and while we can't guarantee you won't break them, it won't be easy.

Drill America® DA30 Parade Rifle

Just a few ounces either way can change the feel and performance of a drill rifle, something drillers quickly learn as they train. Wooden parade rifles can vary in weight by almost half a pound. The Drill America® Parade Rifle, a replica of the 1903 Springfield, lets drillers train with a full-size (42") high impact resin rifle that, at 4.2 lbs., is exactly half the weight of our other Drill America® rifles. Great for parade use and Alternative Arms Drillers. Built to last, these rifles won't fade, crack or discolor over time. Field-tested by school teams, who helped us make this parade rifle a winner. With nickel-plated barrel and bolt, rubber butt plate, operating bolt action and clicking trigger. Includes a black nylon web rifle sling with nickel hardware. No bayonet lug.

- DrillAmerica® DA30 Parade Rifle, black
#DA30BK \$56.95 each
- DrillAmerica® DA30 Parade Rifle, white
#DA30WH \$56.95 each
- DrillAmerica® DA30 Parade Rifle, brown
#DA30BW \$56.95 each

Includes a black nylon web rifle sling!



Tape Your Drill Bar for Better Training!

Your DrillAmerica Drill Bar (page 14) is a great addition to your training regimen! To get the best results, you'll want to make a few key markings on the bar to help build your muscle memory during practice!

NOTE: Your Drill Bar is NOT designed as a substitute for a rifle when LEARNING how to spin. You should ALWAYS learn your techniques on a drill rifle FIRST before using the Drill Bar to build strength & endurance. Glendale Parade Store is not liable for damage due to misuse or substitution for a drill rifle with inexperienced drillers!



Materials Needed:

- Drill Bar
- 3M® Super 88 Black Electrical Tape
- 3M® Super 35 White Electrical Tape
- 3M® Super 35 Colored Electrical Tape (Any color will do!)
- Scissors
- Any Drill Rifle (Our DA1903 would be perfect!)

Step 1: Tape the End Caps

Your Drill Bar comes with 2 rubber end caps. Put them on each end of the bar and affix using the black electrical tape making sure to cover EVERY INCH of the end cap. Wrap this black tape down at least 2 inches below the end cap onto the bar. Use at least 2 layers on each end.

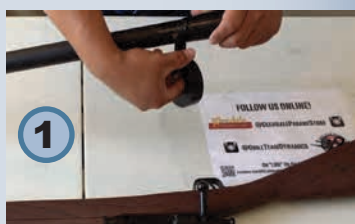

Step 2: Tape Key Positions

Lay your Drill Bar and drill rifle on a flat surface so that the butt of the rifle is aligned to the end of the Drill Bar. Using white electrical tape, mark precisely the following spots:

- Small of the Stock (Just below the metal of the receiver!)
- Mid-Balance Point (Just above the metal of the handguard ring!)
- Stacking Swivel (Just below the lug!)

These are the key contact points for all Regulation Drill rifle manual movements and will assist you in finding the correct positions for your hands as you train!



Step 3: Tape Supporting Positions

With your Drill Bar and drill rifle still aligned, identify any additional positions for the hands you might find important during Exhibition Drill. These positions might include:

- Just Below the Mid-Swivel Band
- Half-Way Between the Mid-Swivel & Lug
- Edge of the Butt Plate

When you train, you can use these marked points to help build the precision required of your Exhibition Drill! Make sure to train precisely for maximum benefit!

For a full video tutorial of this process, visit bit.ly/drillbar.



Happy drilling!

Matt Wendling
World Champion Driller & National Championship Coach



CUSTOMER FAVORITE!

Heavy Web Rifle Slings

Traditional 1 1/4" wide double hook adjustable slings that fit all Glendale rifles, as well as rifles with a swivel opening of 1 1/4" or larger. Sling is 44" long.

White

- Brass hardware #200AB **\$12.50** each
- Nickel hardware #200AN **\$12.50** each

AF Blue

- Brass hardware #200CB **\$12.50** each
- Nickel hardware #200CN **\$12.50** each

Black

- Brass hardware #200BB **\$12.50** each
- Nickel hardware #200BN **\$12.50** each

Olive Drab

- Brass hardware #200DB **\$12.50** each
- Nickel hardware #200DN **\$12.50** each



Leather Rifle Slings

Made from premium quality top grain leather with rich finishes that endure. Double hook, used on U.S. military rifles, is adjustable. Fits all Glendale rifles and all rifles with a swivel opening of 1 1/4" or larger. Available in four colors including high-gloss black Clarino, 1 1/4".

White

- Brass hardware #201B **\$54.95** each
- Nickel hardware #201N **\$54.95** each

Brown

- Brass hardware #203B **\$54.95** each
- Nickel hardware #203N **\$54.95** each

Black

- Brass hardware #202B **\$44.95** each
- Nickel hardware #202N **\$44.95** each

Black Clarino (high gloss)

- Brass hardware #202CB **\$61.95** each
- Nickel hardware #202CN **\$61.95** each

Universal Rifle Sling #206



Universal Rifle Sling

Our most affordable sling. Made of durable 1" Polypro webbing with adjustable buckles. Fits all Glendale rifles. Color: Black.

Universal Rifle Sling #206 **\$8.50** each

Conversion Kits for NGA Stocks

New Guard America High Impact Drill Stock for Demilitarized 1903A3 & 1903 Rifles

Glendale Parade Store is proud to introduce the NGA High Impact Drill Stock, designed to take a beating and keep on drilling. Created in partnership with New Guard America, this stock provides a replacement for demilitarized U.S. Models 1903A3 and 1903. Its super-high-impact resin can withstand even the most drop-prone drillers, making it the perfect stock for the up-and-coming competitor.

Note: This is a stock only, not a complete rifle.

Black

Hand Guard #NGA12BK **\$24.95** each
 Base Stock #NGA1BK **\$99.95** each

Brown

Hand Guard #NGA12BW **\$24.95** each
 Base Stock #NGA1BW **\$99.95** each

White

Hand Guard #NGA12WH **\$24.95** each
 Base Stock #NGA1WH **\$99.95** each

Parts Kits for NGA stocks

Large Parts Kit for NGA

Everything you need to turn your NGA High Impact stock into a competition ready chrome metal drill rifle. Includes all parts shown, plus weight kit and instructions. Stock and hand guard sold separately.

Chrome

#NGALGKIT Complete Conversion Kit **\$219.95** each

Black

#NGALGKITBK Complete Conversion Kit **\$189.95** each

Small Parts Kit for NGA

Now you can retrofit your existing barrel assembly and receiver into an NGA stock. Our kit includes butt plate, trigger guard plate, bolts and screws to fit your NGA stock. Stock and hand guard sold separately.

Chrome

#NGASMKIT Small NGA Kit **\$79.95** each

Black

#NGASMKITBK Small NGA Kit **\$59.95** each

NGA Rubber Butt Plate

To protect floors during indoor drills, replace the existing plate of your NGA rifle with this metal plate covered with 1 cm of molded rubber.

Black Butt Plate #NGA25 **\$13.95** each

Weight Pack

Adds an extra half pound of weight to an NGA stock to meet the 8.5 lb. regulation weight required for competition. Can be placed behind trigger plate, at rear of stock or toward barrel end to create a perfectly balanced rifle

#NGAWT Weights Only **\$12.95** each

New Guard America High Impact Hand Guard #NGA12BK

New Guard America High Impact Base Stock #NGA1BK

Front Band with Bayonet Lug
 Pin
 Stacking Swivel Band

Mid Band and Swivel

Connector Front Pin

Spring

Barrel

Bolt Assembly

Trigger Guard Plate and screws

White #NGA1WH

Brown #NGA1BW

Rear Swivel Plate
 Rear Swivel Screws

Butt Plate and screws

- Large Parts Kit for NGA**
 Includes Small Kit parts plus:
 Barrel
 Connector Front Pin
 Spring
 Front Band with Bayonet Lug
 Front Band Pin
 Receiver Ring
 Connector/Receiver
 Bolt Assembly
 Bolt Stop Screw
 NGA Weight Pack

Small Parts Kit for NGA
 Butt Plate
 Butt Plate Screw (2 sizes)
 Trigger Guard Plate
 Trigger Guard Plate Front Screw
 Trigger Guard Plate Rear Screw
 Mid Swivel
 Mid Swivel Band
 Stacking Swivel Band
 Band Screws (2)
 Rear Swivel Plate
 Rear Swivel Screws (2)



Scan this QR code with your phone or mobile device to shop or see how easy it is to replace a 1903A3 stock. Shop online at <https://glendale.com/chrome-parts-kit-for-nga-stock-large/>



Parts for the DrillAmerica® 1903 Springfield Replica Rifle

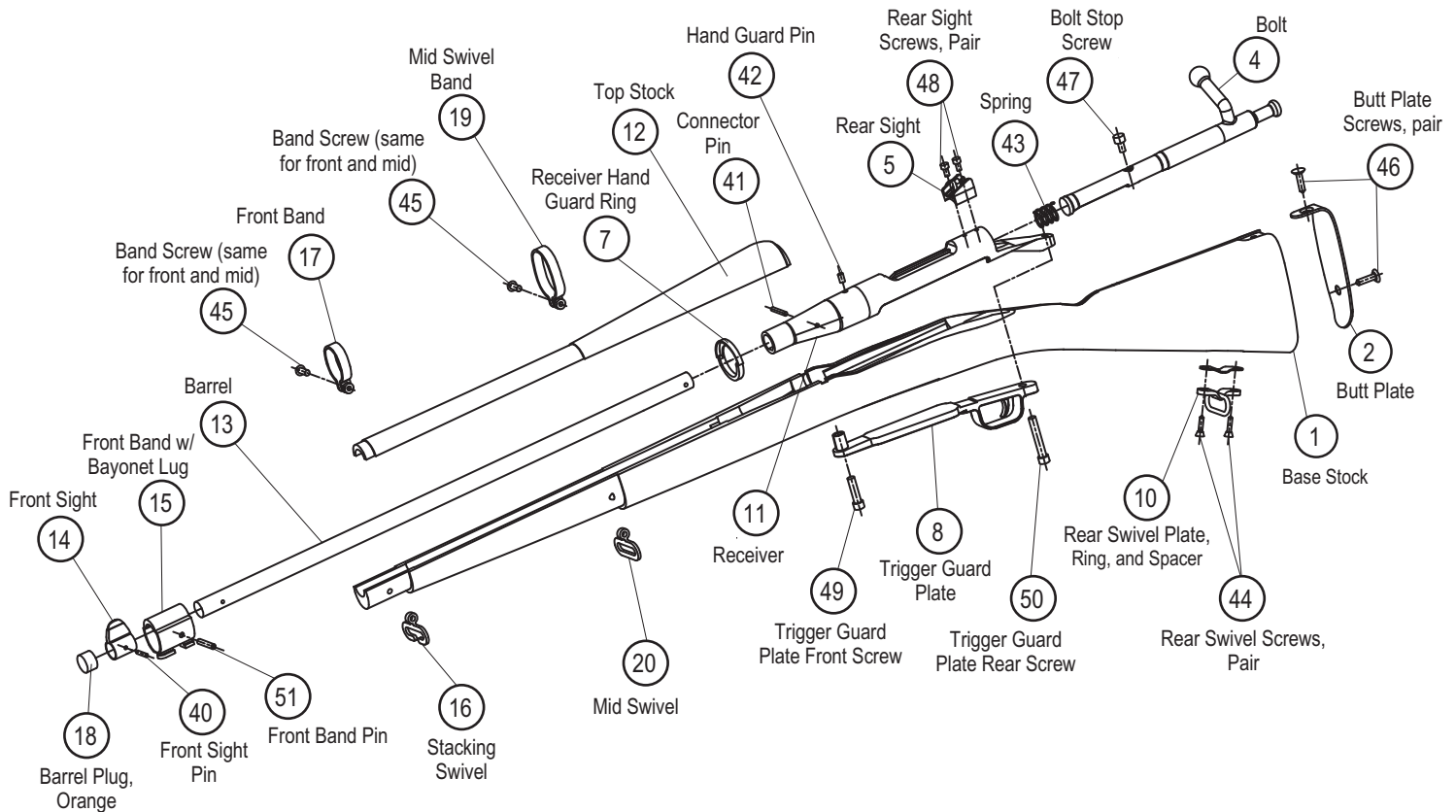

Armed Tee

Whether you are the student, the teacher or a hard core 1903 fan, this tee assures you know your stuff. Pre-shrunk. 100% cotton. Royal Blue. Sizes S,M,L,XL. Back of shirt is blank.

ArmedTee #2168 \$19.95 each

DA1903 Parts							
No.	Description	Chrome		Black		Stock and Misc.	
		SKU	Price	SKU	Price	SKU	Price
2	DA1903 Butt Plate	DASC2	\$13.75	DAS2	\$9.25		
4	DA1903 Bolt Assembly	DASC4	\$36.75	DAS4	\$27.50		
5	DA1903 Rear Sight	DASC5	\$8.50	DAS5	\$6.75		
8	DA1903 Trigger Guard Plate	DASC8	\$30.95	DAS8	\$23.75		
10	DA1903 Rear Swivel Plate, Ring and Spacer	DASC10A	\$9.95	DAS10A	\$8.50		
11,42,7	DA1903 Receiver, Handguard Pin and Ring	DASC311A	\$74.25	DAS311A	\$63.75		
13	DA1903 Barrel	DASC13	\$33.95	DAS13	\$25.25		
14	DA1903 Front Sight	DASC14	\$8.50	DAS14	\$6.75		
15	DA1903 Front Band W/ Bayonet Lug	DASC15	\$9.95	DAS15	\$7.75		
16	DA1903 Stacking Swivel Ring	DASC16	\$7.25	DAS16	\$5.25		
17	DA1903 Front Swivel Band	DASC17	\$7.25	DAS17	\$5.75		
19	DA1903 Mid Swivel Band	DASC19	\$7.25	DAS19	\$5.25		
20	DA1903 Mid Swivel	DASC20	\$7.25	DAS20	\$5.25		
40	DA1903 Front Sight Pin	DASC40	\$1.10	DAS40	\$0.70		
44	DA1903 Rear Swivel Screws, Pair	DASC44	\$1.90	DAS44	\$1.40		
45	DA1903 Band Screw	DASC45	\$0.95	DAS45	\$0.70		
46	DA1903 Butt Plate Screws, Pair	DASC46	\$1.90	DAS46	\$1.40		
47	DA1903 5mm Bolt Stop Screw	DASC47	\$2.25	DAS47	\$1.40		
48	DA1903 Rear Sight Screw, Pair	DASC48	\$1.50	DAS48	\$0.95		
49	DA1903 Trigger Guard Plate Front Screw,	DASC49	\$2.25	DAS49	\$1.70		
50	DA1903 5mm Trigger Guard Rear Screw,	DASC50	\$2.25	DAS50	\$1.70		
1	DA1903 Base Stock Wood Grain, Black (BK) White (WH)					DAS1	\$49.75
12	DA1903 Top Stock Wood Grain, Black (BK) White (WH)					DAS12	\$13.75
18	DA1903 Barrel Cover, Orange					DAS18	\$0.70
	DA1903 Rubber Coated Butt Plate					DAS25	\$14.95
41	DA1903 Connector Front Pin					DAS41	\$0.70
43	DA1903 Bolt Spring					DAS43	\$3.50
44	DA1903 Rear Swivel Screws, Pr					DAS44	\$1.40
51	DA1903 Front Band Pin					DAS51	\$1.40



Wood grain rifle #M30

Wood Replica Springfield Parade Rifles

This detailed version of the 1903 Springfield rifle is designed for parade use only. Made from lightweight wood with nickel-plated barrel and bolt (with operating bolt action and clicking trigger), rubber butt plate and stacking swivel. No bayonet lug. Weights may vary slightly.

- Wood grain rifle with adjustable OD web sling. 42" L. 2.3 lbs. #M30 **\$59.95** each
- Butt Pad 4" H; 1" thick slip-on rubber pad protects floors. #31 **\$9.75** each



For Replica Springfield Parade Rifles #31



For M14 and Springfield #38

Rifle Butt Pads

This 6 oz. slip-on rubber butt pad will unbalance a rifle, but protect floors during training sessions. A great value! For all MK1, MAS1, DA30, and M30 models. For DA1903 models, use DAS25 rubble butt plate. page 13

- For Replica Springfield Parade Rifles M30 and WH30. 4" H; 1" thick. #31 **\$9.75** each
- For M14 and Springfield Drill rifles. 2 1/2" - 3 3/4" #38 **\$36.95** each



DrillAmerica® 9-Pound Weighted Training Rod

Train anywhere anytime with our 9 pound training bar. Weighted like your DA1903, it's an excellent choice for team or individual practice drills. Great for practicing in places where rifles would not be appropriate. Covered in a foam sleeve with molded plastic end caps for added safety.

- 9 lb. Training Rod #DRILLBAR8 **39.95** each*
- *Add \$7 additional shipping if shipped to the lower continental US. Outside the continental US, higher surcharges apply. See page 81 for more information.

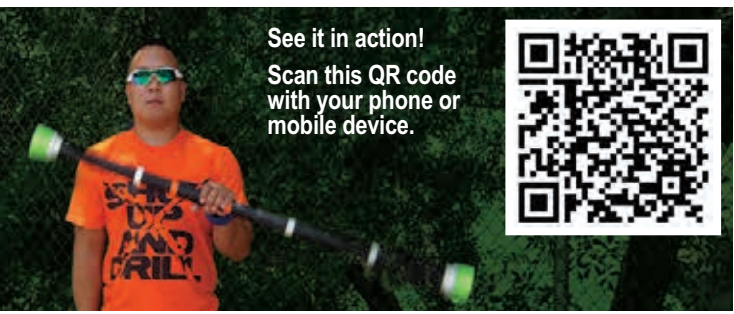

See it in action!
Scan this QR code with your phone or mobile device.



Please Note:

Rifles are NOT RETURNABLE.
Before ordering a quantity of rifles, we suggest ordering a single piece for your examination to be certain it meets your requirements.
Rifles Cannot Be Guaranteed Against Breakage.
You will spin them, throw them, pound them and drop them. Wooden rifles are prone to breakage. For a more durable option consider our DrillAmerica Rifles. They are built really tough, and while we can't guarantee you won't break them, it won't be easy.



Magnetic 22 Gun Rotary Gun Rack



Keep drill rifles tidy and easy to reach. This magnetic gun rack rotates around a 30" pedestal, and securely holds up to 22 rifles in only 30" of floor space. Reduces unnecessary damage and teaches respect for the rifles. Turn any corner into a showcase.

- Magnetic gun rack #GUNRACK-22 **\$574.95** each*
- (*\$25 additional shipping. See page 81 for complete shipping information.)

“Nice speedy delivery.
Keep up the good work”
S. Terry, TN

DVD's and Books

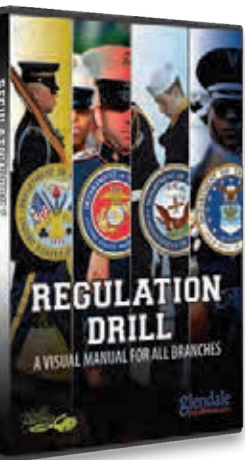

Regulation Drill, a Visual Manual for Air Force, Army, Navy, and Marines



The most comprehensive guides to basic Regulation Drill available anywhere. Glendale Parade Store teamed up with world class drill team training organization Drill-Team Dynamics Inc. to present the commonly executed drill & ceremony movements in strict accordance with the service manual for Army Training Circular 3-21, Air Force Manual 36-2203 and all three major service manuals: Army Training Circular 3-21.5, Marine Corps Order P5060.20, and Air Force Manual 36-2203.

Filmed from multiple angles with slow motion effects, there's no better way to give your cadets a solid understanding of the proper execution of each command on their drill card!

- #938DVD Army Regulation Drill DVD **\$29.95** each
- #939DVD Air Force Regulation Drill DVD **\$29.95** each
- #931DVD Regulation Drill for All Branches DVD **\$36.95** each

More Books, DVD's and Music @ paradestore.com

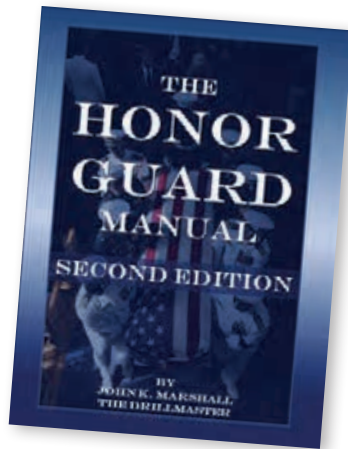

The Honor Guard Manual Second Edition

Updated and expanded, this manual based on the American military standard clearly lays out all ceremonial facets for police, firefighter, EMS, veteran, cadet, fraternal and military honor guard units. Extensive explanations and detailed pictures provide a complete understanding of all aspects. Spiral-bound for easy teaching and learning. Written by John Marshal, 413-page paperback.



- The Honor Guard Manual Second Edition #2359 **\$59.95** each



Airline-approved Single Rifle Case #23



Airline-approved Double Rifle Case #24



Inside Case

Airline-approved Rifle Cases

Designed to withstand the rough and tumble of frequent flying, these tough cases will protect any rifle up to 52" long. Made of high-impact, injection-molded plastic with thick wall construction and high-density egg crate foam inserts. Durable hinges, heavy-duty latches, and oversized, comfortable molded handles. Lockable and airline-approved. Color: Black.

- Single rifle case. 48³/₈"L x 3³/₈"W x 11"H #23 \$42.95 each*
- Double rifle case. 52¹/₈"L x 3³/₈"W x 17"H #24 \$72.95 each*

*Add \$7 additional shipping if shipped to the lower continental US. Outside the continental US, higher surcharges apply. See page 81 for more information.

“Fantastic service!”

All-Purpose Carrying Case with Large Pocket

We designed this special 46¹/₂" x 8³/₄" All-Purpose Carrying Case to hold one or two of any of our drill and parade rifles, swords or sabers. The sides and top are padded, and the end flap is secured with a full-width hook and loop strip. The case boasts a large pocket to hold accessories. Another of its great features—the Navy, exterior polyester duck fabric is waterproof! Sling it over your shoulder with the adjustable shoulder strap or carry it with the durable poly web handle. Personalization available, see below.

All-Purpose Carrying Case #25 \$59.95 each



All-Purpose Carrying Case with Large Pocket #25

Padded Weather-Resistant Carrying Case

Black padded weather-resistant nylon rifle or shotgun case with strong nylon handles and heavy-duty zipper. 48" inside length. A good choice for carrying the full line of DrillAmerica® rifles. Personalization available, see below.

Padded Case #33 \$39.95 each



Case can be personalized

Padded weather-resistant nylon rifle case #33

Personalization available for the #25 and #33 rifle cases on one line with 1" letters in white, gold, or red. Submit imprinted orders in writing.

- Case with Imprinting # 25I or #33I
- A: 1-6 characters/spaces add \$8.00 each
- B: 7-12 characters/spaces add \$12.00 each
- C: 13-22 characters/spaces add \$16.00 each
- Example: to order an imprinted rifle case with 5 gold letters: #33IGOA @ \$47.95.



Rifle Case with Pocket

Made of weather-resistant nylon material with a carrying handle and a loop at the muzzle end of the bag. This fully padded case also has a zippered accessory pocket. 5¹/₂" x 9¹/₂". 48" inside length. Suitable for carrying the full line of DrillAmerica® rifles.

Rifle Case with Pocket #36 \$46.95 each



Rifle Case with Pocket #36

Protective Sleeve

Black nylon sleeve, 44", with drawstring closure to protect second rifle or saber inside our All-Purpose Carrying Case or separately.

Protective Sleeve #25S \$17.25 each



Protective Sleeve for second rifle or sword #25S



Since 1883, Weyersberg, Kirschbaum & Co. (WKC) has manufactured swords and cutlery of impeccable quality in Solingen, Germany, a city famous since the middle ages for its metal-working and craftsmanship in sword making. Today, as the oldest and largest sword manufacturer in Germany, this family-owned business is the leading supplier to military schools and services worldwide. The WKC sword and scabbard are still handmade by skilled sword assemblers and weapon polishers. Even the detailed damascened ornaments of the blades are still etched by hand! No wonder WKC ceremonial swords are worn with pride by U.S. military academies, heads of state, kings and princes, ministers of defense and chiefs of police. Glendale is proud to offer these precision swords and sabers to our customers. Returns for other than defects will be subject to a 15% restocking charge. Engraved Swords can not be returned.

Sabers & Swords

Sizes available on sabers and swords: 28", 30" and 32" blades. All sabers and swords are handcrafted and include scabbards. The Army Saber is carbon steel, nickel plated. All others are stainless steel.

West Point Military Style Sword
#671 **\$437.95** each

Regulation Army Officer Saber
#670 **\$437.95** each

Coast Guard Officer Sword
#691 **\$457.95** each

Marine Corps NCO Sword
#694 **\$465.95** each

Navy Officer Sword
#681 **\$485.95** each

Air Force Honor Guard Sword, 28" and 30" only
#698C **\$421.95** each

Sword/Saber Size Chart

Height of user	Sword size
5'6" to 5'7"	28"
5'8" to 5'11"	30"
6'0" to 6'3"	32"



Sword Engraving **NEW!**

Now you can personalize swords purchased from Glendale! We can engrave up to 20 characters, including spaces. Engraving is only available on new purchases. Engraved Swords can not be returned.

Choose your sword and add an "E" to the item number (ex: #689CE)
\$25.00 each

Scan this QR code with your phone or mobile device learn how to wear a sword, or visit <https://glendale.com/how-to-wear-a-saber-or-sword/>



West Point

Army



West Point Military Style Sword #671



Regulation Army Officer Saber #670



Coast Guard



Coast Guard Officer Sword #691

Marines



Marine Corps NCO Sword #694

Navy



Navy Officer Sword #681

Air Force



Air Force Honor Guard Sword #698C

How to wear a Sword or Saber



Sword

What You'll Need to Wear Each Saber or Sword

For the Army Saber, Navy Officer and Coast Guard Officer Sword:

Start with a saber sling (#105 or #107 on page 19) or attach a #676 saber guard to any leather belt up to 2 1/4". Add the #673 saber chain by hooking the top clip of the saber chain onto the metal clip of the saber guard. The top hook of the saber chain holds the top ring on the scabbard. The lower clip holds the lower ring on the scabbard.

For the West Point and Air Force Sword:

Start with a sword sling (#101 or #106 on page 19) or attach a sword throg (#679 or #680) to any leather belt up to 2 1/4". Insert the scabbard down through the keyhole until the hook is secured.

For the Marine Corps NCO Sword:

Attach the sword throg to any leather belt up to 2 1/4". Insert the hook on the scabbard into the keyhole of the #683 throg.

Mourning Knot:

The #8142 USMC Mourning Knot on page 19 may be worn with any branch of service saber or sword.



Saber

Letter Openers



US Army Officer #670WLO

US Navy Officer #681WLO

USMC Officer #693WLO

USMC NCO #694WLO

Sword/Saber Letter Openers **BEST SELLER**

Exact replicas of the U.S. military swords sold on page 16. Weyersberg, Kirschbaum & Co. (WKC) has manufactured swords and cutlery of impeccable quality in Solingen, Germany, a city famous since the middle ages for its metal-working and craftsmanship in sword making. Today, as the oldest and largest sword manufacturer in Germany, this family-owned business is the leading supplier to military schools and services worldwide. These detailed, attractive and useful letter openers make excellent special gifts and awards. Each comes in a scabbard. Average length is 11".

- USAF Officer #698WLO **\$52.95** each
- US Army Officer #670WLO **\$52.95** each
- US Navy Officer #681WLO **\$52.95** each
- USMC Officer #693WLO **\$52.95** each
- USMC NCO #694WLO **\$52.95** each



The perfect gift!

Our letter openers are beautifully detailed.

USAF Officer #698WLO

Sword and Saber Accessories



Web Sword Slings with Leather Sword Throgs, white #101

White #101 \$59.95 each
Black (not shown) #106 \$59.95 each



USAF Sword Throg, Black #680BK

Throg for Sword Belt, White #679WH

USMC Sword Throg, Black #683BK

Throgs for Sword Belt

Black #679BK \$24.25 each
White #679WH \$31.75 each

USAF Sword Throgs

Made with a special safety loop to hold the scabbard in place.

Black #680BK \$27.50 each
White #680WH \$35.50 each
Black Clarino (high gloss) #680BKC \$39.50 each

USMC Sword Throgs

Black #683BK \$26.75 each
White #683WH \$34.95 each
Black Clarino (high gloss) #683BKC \$39.25 each

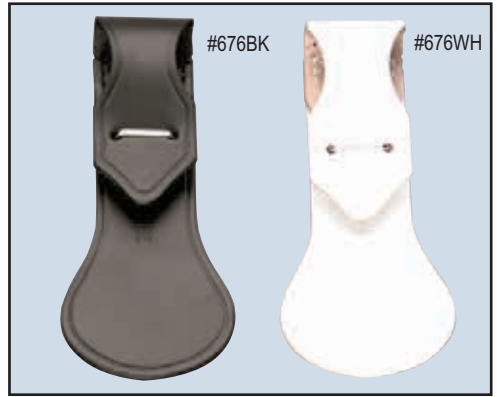

#676BK #676WH

Saber Guards for Sword Belt

Black #676BK \$19.95 each
White #676WH \$24.25 each
Black Clarino #676BKC \$32.50 each



Web Saber Sling and Guard, white #105

Web Saber Slings and Guards

White web sling with white leather Saber Guard. #105 \$59.95 each
Black web sling with black leather Saber Guard (Not Shown). #107 \$59.95 each



USMC Sword Mourning Knot #8142 \$17.50 each



Saber Chain Figure 8 link #673 \$39.25 each



Polishing Cloth #234 \$5.95 each

Polishing Cloth

Blitz 1+1 Polishing and Buffing Cloth removes tarnish, cleans, and polishes.

Polishing Cloth #234 \$5.95 each



Foam-padded Carrying Case #646 \$37.95 each

Foam-padded Carrying Case

Foam-padded, weather-resistant nylon with reinforced nylon web handles and heavy duty zipper. Will hold one sword/saber. 44" L.

Foam-padded Case #646 \$37.95 each

Personalize the #646 case on one line with 1" letters in white, gold, or red.

A: 1-6 characters/spaces add \$8.00 each **B:** 7-12 add \$12.00 each; **C:** 13-18 add \$16.00 each

For example, to order an imprinted sword case with 8 white letters: #646IWHB. Submit imprinted orders in writing.



Calcasieu Parish, LA 2012 Honor Guard Competition Silver Medalists.
The catch was perfect!

Catch Needs to Be Perfect

When a secure hold is a matter of honor, when each slip means a demerit, it's time to graduate to our sure-grip gloves (page 21). While we offer a wide assortment of gloves for every need, our Sure-Grip Flag Bearer Gloves are a clear customer favorite for top competitors.

And for good reason. First and foremost, the patented dots spread over the palms and between the thumb and index fingers and the small and ring fingers secure your grip. Because the gloves are breathable 100% cotton, they stay cool and comfortable even on the hottest of parade grounds. Wrist grips keep them precisely in place. Double reinforcement makes them tough.

To be a top competitor, you need the right equipment. Don't overlook the importance of the right gloves!

SURE-GRIP

Sure Grip Gloves feature patented patterns of rubber-like dots on the fingers and palms to give you the extra grip needed to perform exacting maneuvers with confidence and precision.



No Frills and Extended Sizes

Basic Gloves
Regular 9"



Slip-on Military Gloves
Regular 9"



Black
Long
10½ - 12"

Find your Size

Measure the circumference around the palm at the knuckle area, and convert the numeric measurement to determine size.

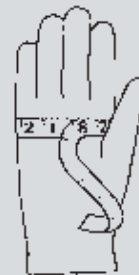

- 6½" XS
- 7" S
- 8" M
- 9" L
- 10" XL
- 10½" XXL
- 11" XXXL

*Washing instructions for cotton and nylon gloves:
DO NOT USE HOT WATER OR BLEACH!*

Hand wash: Soak gloves for 5 minutes in warm water and soap or detergent. Rub gloves together on or off hands. Rinse and dry away from heat.

Machine wash: Cold water, gentle cycle. Dry away from heat.

Basic Glove

Our most affordable glove. White, interlock cotton with rolled hem. (Not available with Sure-Grip.) **Regular 9"** S, M, L, XL

White #1065 \$2.95 pair

Slip-on Military Gloves

A full-fashioned cotton glove at a very affordable price. 3-row stitching on back of hand, and shirring at wrist. (Not available with Sure-Grip.)

Regular 9" XS (white only), M, L, XL, XXL - XXXL (white only)	Long 10½ - 12" (to cover the wrist): S M L XL
White #1050 XS - XL \$3.50 pair	White #1066 \$3.95 pair
White #1050 XXL-XXXL \$3.95 pair	Black #1067 \$4.95 pair
Black #1063 S M L XL \$4.25 pair	



Best quality cotton with a touch of Lycra® stretch for extra comfort.
Long 10½ - 11" (to cover the wrist:) S-M, L-X, XXL-XXXL L.

Sure-Grip

White	S-M	#1078SP	\$8.95 pair
White	L-XL	#1078LP	\$8.95 pair
White	XXL-XXXL	#1078XXP	\$8.95 pair

Plain

White	#1070	\$8.25 pair
-------	-------	--------------------



SURE-GRIP
 Honor Guard
 Gloves

*Long
 10½" - 11"*

Sure-Grip Flag Bearer Gloves CUSTOMER FAVORITE!
 When one slip can spoil the show, you can depend on the Sure-Grip palm and fingers of our best-selling cotton gloves. Flag-bearers, drill corps, and baton twirlers will appreciate the added control and the durability of double reinforced material between thumb and index finger and between small and ring fingers. Velcro® strap at wrist. **Regular** 9" XS, S, M, L, XL

Sure-Grip

White	#1068	\$6.25 pair
Black	#1069	\$7.25 pair



SURE-GRIP
 Sure-Grip Flag
 Bearer Gloves

*Snug fit Velcro®
 wrist grips*

Black

No Slip with Sure-Grip

Fleece Lined Gloves



Regular 9"

SURE-GRIP

*Long
 10½"*

Snap Military Gloves
 available with
 Sure-Grip



SURE-GRIP

**Sure-Grip
 Parade Gloves**

Regular 9"



Black
SURE-GRIP

Warm Fleece-Lined Gloves

In blustery weather, you'll appreciate the warmth of the light fleece lining inside these breathable, comfortable top quality gloves. Regular is pure cotton. 3-row stitching on back of hand. Long version is cotton/Lycra®. Plain Palm style has shirring at wrist.

Regular 9" S-M or L-XL

Plain palm	#1075	\$4.75 pair
------------	-------	--------------------

Long 10½"-12" (to cover the wrist:)

S-M or L-XL

Plain palm	#1076	\$11.50 pair
------------	-------	---------------------

Sure-Grip	#1077	\$12.25 pair
------------------	-------	---------------------

Snap Military Gloves

These all cotton military style gloves have become standard issue for special events. Full-fashioned for exceptional comfort and control, with 3-row stitching on back and snap wrist. Regular 9" S, M, L, XL; XS, XXL (plain only)

Sure-Grip

White	#1057	\$4.95 pair
-------	-------	--------------------

Plain

White XS - XL	#1051	\$3.95 pair
---------------	-------	--------------------

White XXL	#1051	\$4.25 pair
-----------	-------	--------------------

Sure-Grip Parade Gloves

These all cotton gloves provide added dexterity, thanks to the Sure-grip dots on the palm. 3-row stitching on back of hand. Slip-on; wrist length. **Regular 9"**(shown). S, M, L, XL, White only for 2XL. **Long 10½"-12"** (to cover the wrist:) M (Ladies) and XL (Mens) only.

Sure-Grip

White Regular	#1055	\$3.95 pair
---------------	-------	--------------------

Black Regular	#1056	\$4.50 pair
---------------	-------	--------------------

White Long	#1058	\$4.75 pair
------------	-------	--------------------



Enloe HS, AJROTC 2019 Nationals.



Two-color Stretch Poly Gloves

Add a splash of style! Parade gloves with white backs have colorful palm colors to show off your team spirit. Easy-care, comfy stretch polyester. With white back, available palm colors are: orange, purple, maroon, gold, royal blue, red, kelly green, black, and navy.

Regular 9" slip on. One size fits most.
Poly Gloves #6401FP **\$6.50** pair



Solid Color Stretch Poly Gloves

Solid Stretch Poly Gloves

Show your colors with pride and in comfort with these easy-care stretch poly gloves. Available in navy, orange, purple, maroon, gold, royal blue, red, kelly green and black.

Regular 9" slip on. One size fits most.
Solid Stretch Poly Gloves #6401SCP **\$5.95** pair

Men's Stretch Poly Gloves



Men's Stretch Poly Gloves

Sized for larger hands. Cozy stretch polyester fabric is also easy care. Colors: black, gold, kelly green, royal blue and red. Black snaps on black; white snaps on gold, kelly green, royal, and red.

Regular 9" slip on. One size fits most.
Men's Poly #6400SCMP **\$6.50** pair



Wrist Wraps

Adapted from the same accessory used by the 3rd United States Infantry (The Old Guard) and the Sentinels at the Tomb of the Unknowns in Arlington National Cemetery. Prevent the showing of any skin around the wrist/forearm area when handling rifles or saluting—a small but important detail to look your finest when properly presenting honors!

White #1087 **\$13.25** pair
Black #1085 **\$13.25** pair



Formal Stretch Nylon Gloves

Stretch nylon is a popular choice for gloves that need to withstand repeated use and still look great. Full-fashioned for form-fitting comfort and control. 3-row stitching on back. (Not available with Sure-Grip.)

Regular 9" slip on one size fits most
Slip-on #6400PR **\$4.25** pair
Snap Wrist #6400SP **\$4.95** pair

Men's Stretch Nylon Gloves

Heavier weight nylon, snap wrist. Large only

Regular 9" #6402S \$5.50 pair

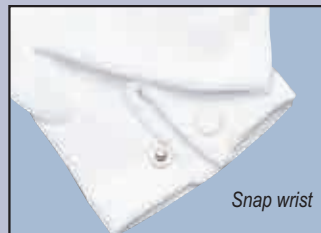

Snap wrist

Formal Nylon Gloves



Slip-on #6400

Add Cords the Easy Way with Pins

Glendale was the first to introduce pin-on cords and still has the best selection. Pins are the easy way to add cords to any uniform. In fact if you want to create custom cords, you can add pins to any of our Shoulder Cords for \$3.

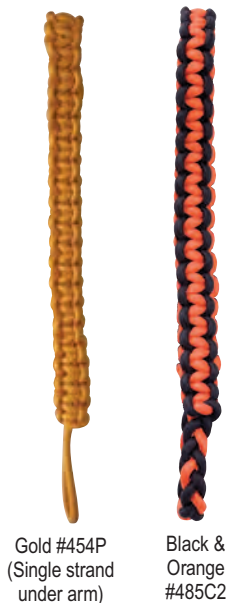

2019 National Drill championships

Infantry Style Shoulder Cords with Pins Double Strand Under Arm

Shoulder Cord with Pin in one poly color.	#485	\$18.25 each
Shoulder Cord with Pin in any two poly colors.	#485C2	\$20.75 each
Shoulder Cord with Pin in metallic gold or silver.	#486	\$23.95 each
Shoulder Cord with Pin in metallic gold or silver, plus any one poly cord.	#486C2	\$25.75 each
Breast Cancer Awareness shoulder top cord with pin	#485PK	\$18.25 each

Infantry Style Shoulder Cords with Pins Single Strand Under Arm

Shoulder Cord with Pin in one poly color.	#454P	\$18.75 each
Shoulder Cord with Pin in any two poly colors.	#454C2P	\$21.25 each
Shoulder Cord with Pin in metallic gold or silver.	#455P	\$22.95 each
Shoulder Cord with Pin in metallic gold or silver, plus any one poly cord.	#455C2P	\$24.50 each



MADE-TO-ORDER CORDS
Cords can be custom made in two longer lengths. Add \$5 to the prices for an additional 5" and \$8 for an additional 10". Then, add the length to the number - for example, #485X5, #466C2X10.

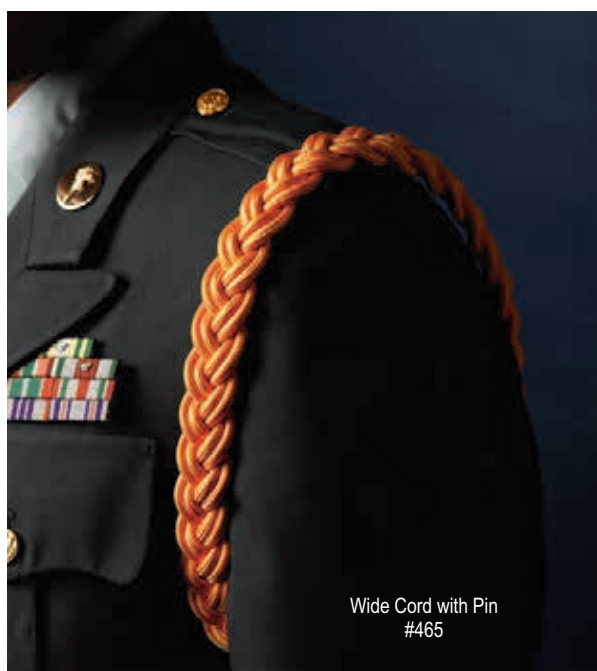

Wide Braid Cords with Pins

In any one poly color with pin.	#465	\$22.75 each
Above cord in any two poly colors.	#465C2	\$26.75 each
Above cord in metallic gold or silver.	#466	\$29.95 each
Above cord in metallic gold or silver, plus any one non-metallic cord.	#466C2	\$31.50 each

When ordering two colors in this cord, no color will be dominant.



5 Infantry Style Cord Options all made in America!



Button Loop
Cord
#452



Shoulder Top
Cord
#454



Epaulet Cord
#456



Shoulder
Cord with Pin
#485



Shoulder Cord
with Pin
#454P



Button Loop
Cord
#452



Shoulder Top
Cord
#454



Epaulet Cord
#456



Shoulder Cord
with Pin
#485

Double strand
under arm

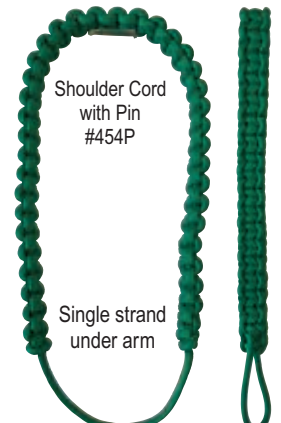

Shoulder Cord
with Pin
#454P

Single strand
under arm

Poly Cord

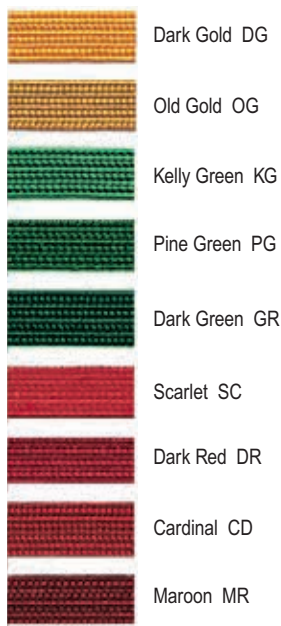

METALLIC CORD



See page 30 for Glendale's Color Compatibility Chart

MADE-TO-ORDER CORDS

Longer Lengths: Styles #452, #454 and #456 can be custom-made in two longer lengths. Add \$5 to the prices for an additional 5" and \$8 for an additional 10". Then, add the length to the number — for example, #452X5, #454X10, #452C2X10

• Pin Attachment: Any cord with a button loop can be custom-made with a pin attachment to wear on uniforms without buttons or epaulets. Add \$3 to the price of each cord and a "P" (for pin) to the product number — for example, #452P.

Allow 4 weeks for delivery.



Special Color Orders

All 2-color and 3-color cords are made to customer specifications and are not returnable. Special color orders and combinations may require 4 weeks for delivery.



Not sure about what color you need or what will match something else you already have?

Infantry Style Shoulder Cords

For color brilliance, thickness, smoothness, strength, and weight, we really do have the finest cords made in the United States! Each cord — braided, knotted, and sewn by hand — is a true testament to quality and craftsmanship. Because the same U.S. factory both creates the braid and makes the finished cord, our customers are assured of consistent top quality year after year.

The button loop-style is designed to be worn with an epaulet that unbuttons. The open-end style with hook-and-eye closure is designed for epaulets that do not open. The wrapped pin attachment style can be worn on uniforms or shirts without epaulets or with epaulets that unbutton.

Think Pink Shoulder Cord **CUSTOMER FAVORITE!**

Wear a pink cord and show you care! Use our button-loop bright pink shoulder cord for fundraising and to reward your cadets for community service in the fight against breast cancer. We're proud to donate a portion of the proceeds for every sale of this cord to the Susan G. Komen Foundation.

Breast Cancer Awareness cord with button loop	#452PK	\$13.95 each
Breast Cancer Awareness shoulder top cord with pin	#485PK	\$18.25 each

Button Loop Cord **CUSTOMER FAVORITE!**

Button Loop Cord in any one poly color.	#452	\$13.50 each
Button Loop Cord in two poly colors.	#452C2	\$14.95 each
Button Loop Cord in metallic gold or silver.	#453	\$16.75 each
Button Loop Cord in metallic gold or silver, plus any one poly cord.	#453C2	\$18.50 each

Shoulder Top Cord

Bright poly cord with full shoulder braid, wide loop, hole underneath for epaulet to pass through, and single underarm cord.

Shoulder Top Cord in one color.	#454	\$15.75 each
Shoulder Top Cord in two colors.	#454C2	\$18.25 each
Shoulder Top Cord in metallic gold or silver.	#455	\$19.95 each
Shoulder Top Cord in metallic gold or silver, plus any one poly cord.	#455C2	\$21.50 each

Epaulet Cord

Bright poly cord with open ends and hook-and-eye closure. These are suitable for uniforms with permanently affixed epaulets.

Epaulet Cord in one color.	#456	\$17.95 each
Epaulet Cord in two colors.	#456C2	\$19.95 each
Epaulet Cord in metallic gold or silver.	#457	\$22.50 each
Epaulet Cord in metallic gold or silver, plus any one poly cord.	#457C2	\$24.95 each

Shoulder Cords with Pins Double Strand Under Arm

Shoulder Cord with Pin in one poly color.	#485	\$18.25 each
Shoulder Cord with Pin in any two poly colors.	#485C2	\$20.75 each
Shoulder Cord with Pin in metallic gold or silver.	#486	\$23.95 each
Shoulder Cord with Pin in metallic gold or silver, plus any one poly cord.	#486C2	\$25.75 each
Shoulder Cord with Pin in silver luminette.	#486SL	\$39.95 each

Shoulder Cords with Pins Single Strand Under Arm

Shoulder Cord with Pin in one poly color.	#454P	\$18.75 each
Shoulder Cord with Pin in any two poly colors.	#454C2P	\$21.25 each
Shoulder Cord with Pin in metallic gold or silver.	#455P	\$22.95 each
Shoulder Cord with Pin in metallic gold or silver, plus any one poly cord.	#455C2P	\$24.50 each

MADE-TO-ORDER CORDS

Cords are 28' in length and can be custom made in two longer lengths. Add \$5 to the prices for an additional 5" and \$8 for an additional 10". Then, add the length to the number – for example, #454X5, #450C2X10

“You are the Best in the business. I try to spread the word about your company. None Better!!”

J.B., Powell WY

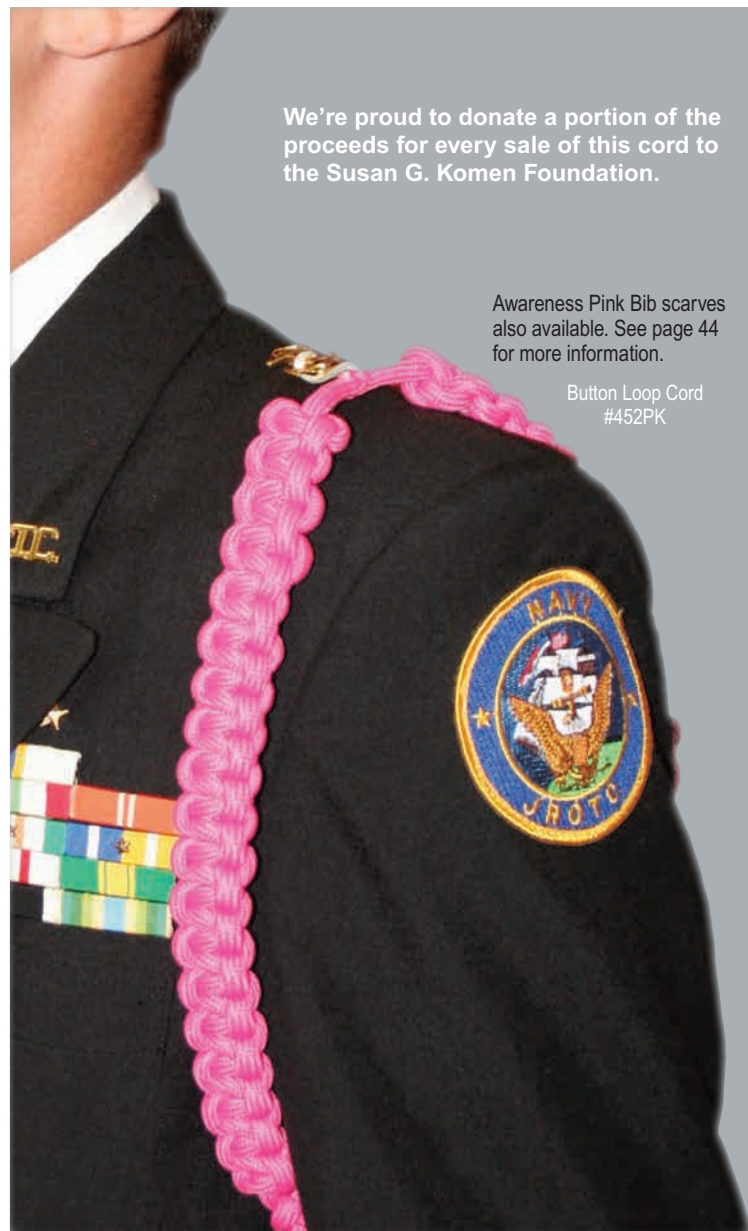

We're proud to donate a portion of the proceeds for every sale of this cord to the Susan G. Komen Foundation.

Awareness Pink Bib scarves also available. See page 44 for more information.

Button Loop Cord
#452PK



Two color cords

When ordering two colors in any infantry style cord, the first color you list will be on outer edges.

Photos of two-color cords are shown to indicate placement of color choices.

All 2-color and 3-color cords are made to customer specifications and are not returnable. Special color orders and combinations may require 4 weeks for delivery.

Two-color Cords
Gold & Navy
#452C2



Rattler Guard Drill Team
Ronald Reagan HS Army JROTC,
San Antonio, TX

Shoulder Cords



Double Knot Loop Cords
#482



Navy & Gold
#482C2



Double Circle Braided Cord
#480



Royal Blue & White
#480C2

Double Knot Loop Cords

- Any one poly color. #482 **\$18.25** each
- Above cord in two poly colors. #482C2 **\$21.95** each
- Above cord in metallic gold or silver. #483 **\$23.25** each
- Above cord in metallic gold or silver, plus any one non-metallic cord. #483C2 **\$26.95** each



When ordering two colors in this cord, the second color you list will be the color of the double knot loops

Double Circle Braided Cords

- Any one poly color. #480 **\$21.50** each
- Above cord in two poly colors. #480C2 **\$24.75** each
- Above cord in metallic gold or silver. #481 **\$27.25** each
- Above cord in metallic gold or silver, plus anyone non-metallic cord. #481C2 **\$29.25** each



When ordering two colors in this cord, the first color you list will be dominant in both braided cords.

The Easiest, Fastest Way to Get Custom Cords in 26 Colors!



Single Strand Shoulder Cord
#460

glendale
exclusive

MADE-TO-ORDER CORDS

Standard length is 28 inches
LONGER LENGTHS: Styles on this page can be custom-made in two longer lengths. Add \$5 to the prices for an additional 5" and \$8 for an additional 10". Then, add the length to the number — for example, #480X5, #458X5, #482C2X10.

PIN ATTACHMENT: Any shoulder cord with a button loop can be custom-made with a pin attachment to wear on uniforms without buttons or epaulets. Add \$3 to the price of each cord and a "P" (for pin) to the product number — for example, #458P.

Allow 4 weeks for delivery.

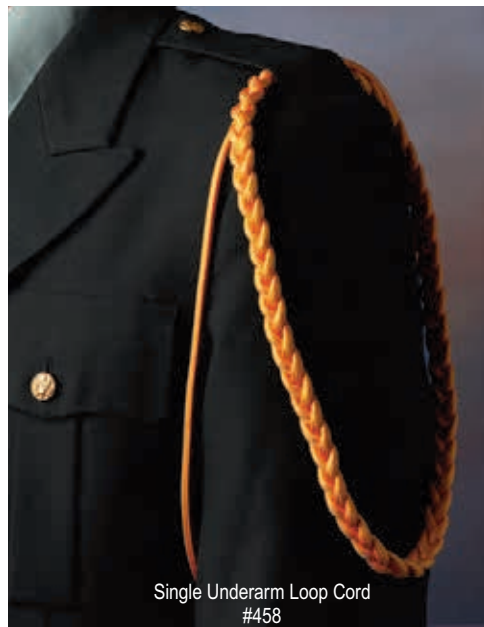

Single Underarm Loop Cord
#458



Kelly Green and White
#458C2

Single Strand Shoulder Cord



This single cord with a button loop will add a simple, clean line of color to a uniform or shirt. It's 28" round.

- Single Strand Shoulder Cord #460 **\$8.25** each

Single Underarm Loop Cords



- Any one poly color. #458 **\$12.25** each
- Above cord in two poly colors. #458C2 **\$15.25** each
- Above cord in metallic gold or silver. #459 **\$15.75** each
- Above cord in metallic gold or silver, plus any one non-metallic cord. #459C2 **\$18.25** each

When ordering two colors in this cord, the second color you list will be the color of the underarm loop cord.



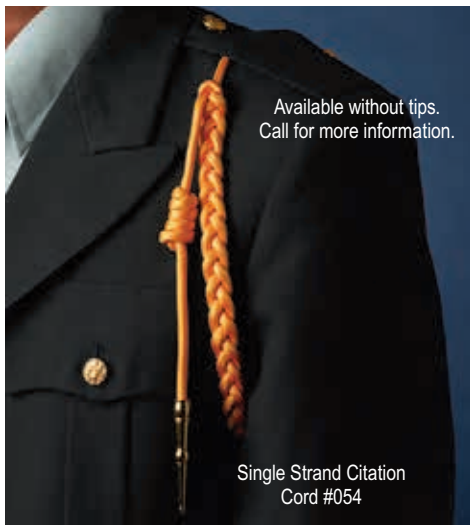

Available without tips.
Call for more information.

Single Strand Citation
Cord #054



Navy & Gold
#054C2

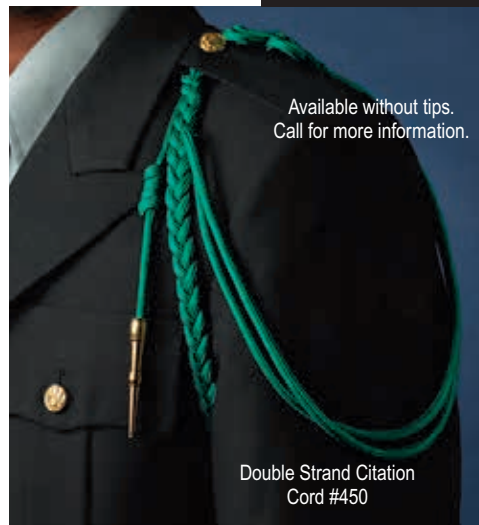

Available without tips.
Call for more information.

Double Strand Citation
Cord #450



Royal Blue, White, Scarlet
#450C3

Single Strand Citation Cords

- Bright cord in any one color, brass or nickel tip, button loop. #054 **\$17.75** each
- Above cord in two poly colors, brass or nickel tip. #054C2 **\$20.75** each
- Above cord in metallic gold or silver, brass or nickel tip. #055 **\$21.75** each
- Above cord in metallic gold or silver, plus any one poly cord, brass or nickel tip. #055C2 **\$23.75** each



Double Strand Citation Cords

- Bright poly cord double strand, brass or nickel tip, button loop. #450 **\$18.25** each
- Above cord in one color, brass or nickel tip. #450C2 **\$23.25** each
- Above cord in two colors, brass or nickel tip. #450C3 **\$27.75** each
- Above cord in three colors, brass or nickel tip. #450C3 **\$27.75** each
- Above cord in metallic gold or silver, brass or nickel tip. #451 **\$20.95** each
- Above cord in metallic gold or silver, plus one non-metallic cord, brass or nickel tip. #451C2 **\$25.75** each
- Above cord in metallic gold or silver, plus two other non-metallic cords, brass or nickel tip. #451C3 **\$29.95** each



Ordering Cord Tips

All Citation cords on this page come with your choice of brass or nickel tips. Order by placing B (for brass) or N (for nickel) after the number and before the color code. For example, #450C3NNVWHSC or #054C2BNVGO.

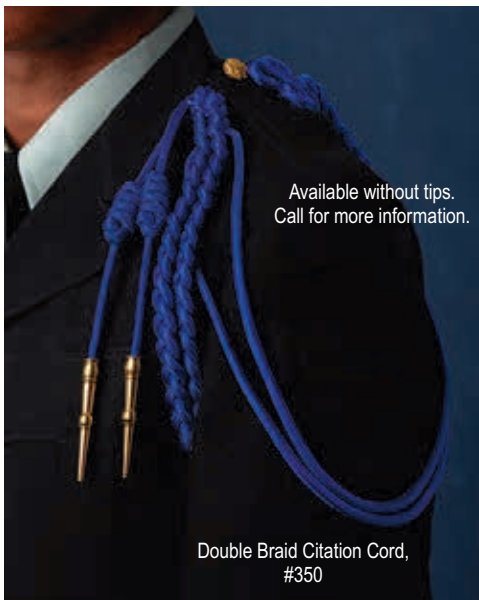

Available without tips.
Call for more information.

Double Braid Citation Cord,
#350



Maroon & Gold
#350C2

Special Color Orders

When ordering two colors in the cords on this page, the first color you list will be on the hang cord. Photos of each two-color cord are shown to indicate placement of color choices. All 2-color and 3-color cords are made to customer specifications and are not returnable. Special color orders and combinations may require 4 weeks for delivery.



#450C2

Double Braid Citation Cords



- Bright poly cord in any one color, brass or nickel tips, button loop. #350 **\$33.95** each
- Cord in two poly colors, brass or nickel tips. #350C2 **\$39.95** each
- Cord in metallic gold or silver, brass or nickel tips. #351 **\$46.25** each
- Cord in metallic gold or silver, plus any one poly cord, brass or nickel tips. #351C2 **\$48.25** each

Not sure about what color you need or what will match something else you already have?



Poly Cord

- White WH
- Black BK
- Jay Blue JB
- Infantry Blue IB
- Medium Blue MB
- Royal Blue RY
- Teal TL
- Navy Blue NV
- Gold GO

- Dark Gold DG
- Old Gold OG
- Kelly Green KG
- Pine Green PG
- Dark Green GR
- Scarlet SC
- Dark Red DR
- Cardinal CD
- Maroon MR

- Gray GY
- Orange OR
- Purple PR
- Buff BU
- Brown BW

METALLIC CORD

- Metallic Silver (MS)
- Metallic Gold (MG)
- Silver Luminette (SL) (For Shaker Knot Honor Cord 484, Shoulder Cord with Pin 486, USAF Dress 622 and USAF Honor Guard Cord 638 only.)

See page 30 for Glendale's Color Compatibility Chart

Aiguillettes Handmade with Pride in the USA



#630 (US Army Dress)

US Army Dress Aiguillettes

Two-piece cord with two button loops and pin attachments. 

Any one poly color, brass or nickel tip, #630 **\$53.95** each

Above cord in two poly colors, brass or nickel tip. #630C2 **\$66.95** each

When ordering two colors in this cord, the first color you list will be on hang cord.



Gold & Maroon #630C2



Not sure about what color you need or what will match something else you already have?

Ordering Aiguillettes Tips

All Aiguillettes come with your choice of brass or nickel tips. Order by placing B (for brass) or N (for nickel) after the number and before the color code. For example, #630C2BGOMR.

Also available:

Aiguillettes to wear on the right shoulder may be custom ordered.

Add \$8 for silver or gold metallic cord. Add \$3 to change from button loop to pin attachment (add P to the product number).

See page 30 or the chart of the best color matches for bib scarves, berets, shoulder cords, and gloves.

Cord Tips

Add Army (with eagle and starburst) or Air Force Hap Arnold tips as shown to any Aiguillette for just \$14.95 per tip. See page 31 for ordering details.



#636 (US Army Service)

US Army Service Aiguillettes



Open ends with two pin attachments.

Any one poly color, brass or nickel tip. #636 **\$27.95** each

Above cord in two poly colors, brass or nickel tip. #636C2 **\$30.75** each

When ordering two colors in this cord, the first color you list will be on hang cord.



Black & Gold #636C2

Poly Cord

	White WH
	Black BK
	Jay Blue JB
	Infantry Blue IB
	Medium Blue MB
	Royal Blue RY
	Teal TL
	Navy Blue NV
	Gold GO

	Dark Gold DG
	Old Gold OG
	Kelly Green KG
	Pine Green PG
	Dark Green GR
	Scarlet SC
	Dark Red DR
	Cardinal CD
	Maroon MR

	Gray GY
	Orange OR
	Purple PR
	Buff BU
	Brown BW

METALLIC CORD

	Metallic Silver (MS)
	Metallic Gold (MG)
	Silver Luminette (SL) (For Shaker Knot Honor Cord 484, Shoulder Cord with Pin 486, USAF Dress 622 and USAF Honor Guard Cord 638 only.)

See page 30 for Glendale's Color Compatibility Chart to match Bib Scarves, Berets, and Cords



Black & Cardinal
#622C2

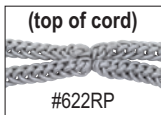

#622RP

Longer cords are available call 800-653-5515 for more information



Available without tips. Call for more information.

#622R (USAF Dress)



Royal Blue & Gold
#638C2



#638RO USAF Honor Guard, Officer

Connection lies flat under epaulet!



#638R USAF Honor Guard, Enlisted



Available without tips. Call for more information.

#638R (USAF Honor Guard, Enlisted)

USAF Dress

- Bright poly cord, any one color, brass or nickel tips, with button loop. #622 **\$69.95** each
 - Above cord in two poly colors, brass or nickel tips. #622C2 **\$74.95** each
 - Above cord in silver luminette with Hap Arnold tips and barrels. #622R **\$153.75** each
 - USAF Dress Aiguillette in silver luminette with Hap Arnold tips and barrels, pin attachment. #622RP **\$155.75** each
- When ordering two colors in this cord, the first color you list will be in the larger braid.*



USAF Service

- Any one poly color, brass or nickel tip, with pin attachment. #638 **\$46.25** each
 - Above cord in two poly colors, brass or nickel tip. #638C2 **\$49.25** each
 - USAF Honor Guard Cord in silver luminette with Hap Arnold tip and barrel and pin attachment, Enlisted. #638R **\$83.25** each
 - USAF Honor Guard Cord in silver luminette with Hap Arnold tip and barrels, Officer. #638RO **\$76.25** each
- When ordering two colors in this cord, the first color you list will be on hang cord.*
- Shaker Knot Honor Cord with Pin, Silver luminette only (see page 23)
#484SL **\$56.95** each

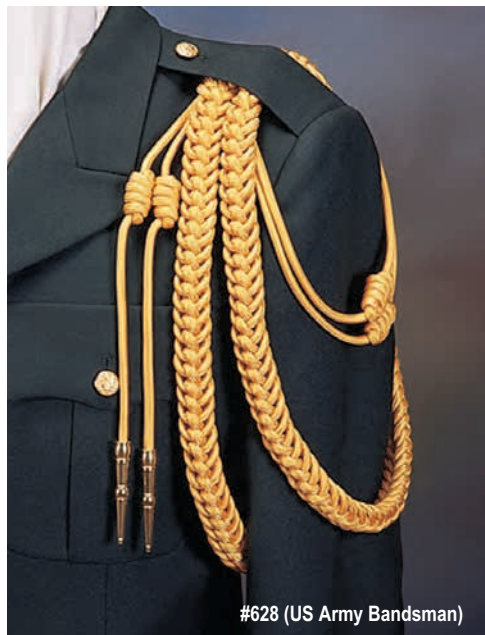

#628 (US Army Bandsman)



Available without tips. Call for more information.

#632 (USAF Bandsman)



#626 Single Braid/ Double Knot Aiguillettes



Purple & White
#628C2

US Army Bandsman

- Any one poly color, brass or nickel tips, with button loop. #628 **\$72.95** each
 - Above cord in two poly colors, brass or nickel tips. #628C2 **\$79.95** each
- When ordering two colors in this cord, the first color you list will be on hang cord.*



Gold & Dark Green
#632C2

USAF Bandsman

- Any one poly color, brass or nickel tips, with button loop. #632 **\$67.50** each
 - Above cord in two poly colors, brass or nickel tip. #632C2 **\$73.50** each
- When ordering two colors in this cord, the first color you list will be in the larger braid.*



Dark Red & Royal Blue
#626C2

Single Braid/ Double Knot Aiguillettes

- Any one poly color, brass or nickel tips, with button loop. #626 **\$47.95** each
 - Above cord in two poly colors, brass or nickel tips. #626C2 **\$53.50** each
- When ordering two colors in this cord, the first color you list will be on hang cord.*



Wide shaker knot cords on this page cannot be interwoven in two colors.

Mourning Shoulder Cords & Cord Add-Ons

Mourning Cords

This shoulder cord is the start of a new tradition for funeral honor guards. It was designed by a member of a police honor guard and, like all Glendale shoulder cords, is handcrafted in the U.S. The funeral honor guard stands at attention – a mourning band covers each member's badge. Each uniform also displays a unique mourning shoulder cord – black with a thin blue line for police, black with a thin red line for firefighters, black with a thin green line for EMS. It's a finished, distinctive and respectful look.

These cords generally have a 28" circumference. They can be custom-made in two longer lengths. Add \$5 to the price for an additional 5" and \$8 for an additional 10". Then, add the length to the number -- for example, #4521106X5 or #4561107X10.



- Police (Blue)**
- Police, button loop. #4521106 **\$27.75** each
 - Police, pin attachment #4521106P **\$27.75** each
 - Police, open ends, hook and eye closure. #4561106 **\$27.95** each
- Firefighter (Red)**
- Firefighter, button loop. #4521107 **\$24.75** each
 - Firefighter, pin attachment #4521107P **\$27.75** each
 - Firefighter, open ends, hook and eye closure. #4561107 **\$27.75** each
- Emergency Medical Services (Green)**
- EMS, button loop. #4521108 **\$24.75** each
 - EMS, pin attachment #4521108P **\$27.75** each
 - EMS, open ends, hook and eye closure. #4561108 **\$27.95** each

#4521107
Firefighter Cord: Black with Red center, button loop



#4561106
Police Cord: Black with blue center, hook and eye

#4521108
EMS Cord: Black with green center, button loop

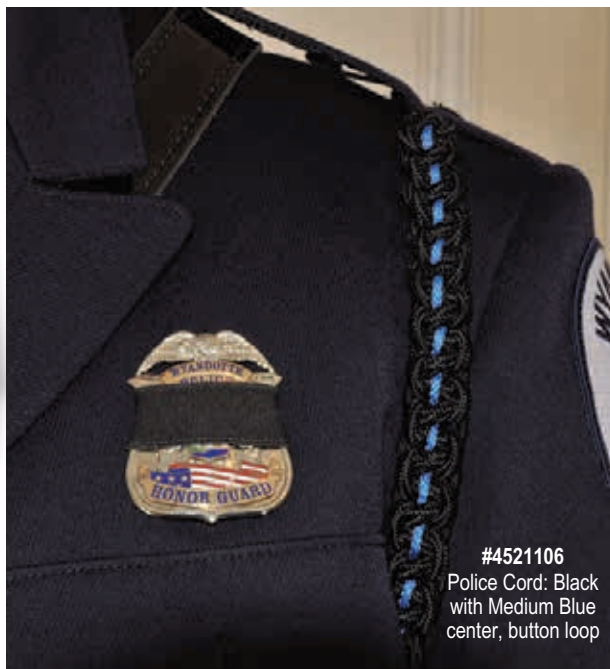

#4521106
Police Cord: Black with Medium Blue center, button loop

The button loop-style (shown here) is designed to be worn with an epaulet that unbuttons. The open-end style with hook-and-eye closure is designed for epaulets that do not open. The wrapped pin attachment style can be worn on uniforms or shirts without epaulets or with epaulets that unbutton.



Badge Mourning Bands are shown on page 53.

Cord Add-Ons **BEST SELLER!**

Details, details – it's all in the details! Change a cord, enhance a cord, add flair. Anything's possible with our exclusive line of Add-Ons. Pin them on to any cord to create your own distinctive look!



Hang Cord

- Bright polycord in any one color, brass or nickel tip with pin and safety catch attachment. #056 **\$9.95** each
- Above cord in metallic gold or silver, brass or nickel tip. #057 **\$10.95** each

Knotted Loop Cords

These pin-on cords are available in any one poly or metallic cord color — in a single 8" or 9" length or in a double combination cord with both an 8" and 9" loop.

- Single Loop, 8" in any one poly color. #062 **\$7.95** each
- Single Loop, 8" in any one metallic color. #063 **\$8.95** each
- Single Loop, 9" in any one poly color. #064 **\$7.95** each
- Single Loop, 9" in any one metallic color. #065 **\$8.95** each
- Double Loop, 8" & 9" in any one poly color. #066 **\$10.95** each
- Double Loop, 8" & 9" in any one metallic color. #067 **\$14.25** each



Hang Cord Gold #056



Glendale's Color Compatibility Chart

If you're trying to match scarves, berets and shoulder cords in the same color, the most compatible matches (barring any changes in manufacturers' colors or dye lots) are indicated in the following chart. Color swatches are available for scarves, berets and cords.

BIB SCARVES	BERETS	CORDS
White 011, 014, 015, 020	—	White
—	White 4024, 4051	White
Scarlet 011, 014, 015, 020	Scarlet 4024, 4051, 4062, 4063 Dark Red 4062, 4063	Scarlet
Dark Orange 014	Orange 4062, 4063	Orange
Maroon 014, 015	Maroon 4024, 4051, 4062, 4063	Maroon
Purple 015	Purple 4024, 4051	Purple
Navy Blue 011, 014, 015, 020	Navy Blue 4062, 4063	—
Light Navy Blue 015	Navy Blue 4024, 4051	Navy Blue
Infantry Blue 015	—	Infantry Blue
Royal Blue 011, 014	Royal Blue 4024, 4051	Royal Blue
Royal Blue 011, 015, 020	Royal Blue 4062, 4063	—
Academy Royal Blue 015	Academy Royal Blue 4062, 4063	—
Teal 015	—	Teal
Dark Green 015	—	Dark Green
Kelly 015, 020	—	Kelly
Dark Gold 011, 015, 020	Gold 4024, 4051	Dark Gold
Gold 014	Gold 4024, 4051	Dark Gold
Buff 015	—	Buff
Black 011, 014, 015, 020	Black, all styles	Black
Charcoal Gray 015	Gray 4062, 4063	—
—	Kelly 4024, 4051, 4062, 4063	Pine Green

Cap Cords

For Stratton Campaign Hats see page 48, shop online at www.ParadeStore.com, or call 1-800-653-5515 so we may assist you.



Campaign Cap Cords, Metallic Gold #783



Cord Tips
 Army or Air Force tips may be added to any hang cord on any citation cord or aiguillette at an additional charge of **\$15.50** per tip. When ordering, add A or AF to cord number. These cords are made to customer's specifications, so please allow extra time for the manufacturing process. If ordering tips alone to be sewn on at your location:

Army tip and barrel with eagle and starburst, brass	#4612	\$14.95 each
Air Force Hap Arnold tip and barrel, nickel	#4613	\$14.95 each
Plain brass tip and barrel	#4614	\$4.95 each
Plain nickel tip and barrel	#4615	\$4.95 each



Campaign Cap Cords

You'll appreciate our cap cords for their color brilliance, thickness, smoothness, strength, and weight. Any quantity may be ordered in black, brown, dark gold, gold, kelly, navy, royal, scarlet, white, metallic gold, or metallic silver. For all other colors, 12 of each color is the minimum order. All colors are shown below.

Any one poly color	#782	\$9.95 each
Metallic gold or silver	#783	\$10.95 each



Double-knotted Cap Cord

Standard length is 12"; cords are not adjustable. Remove buttons and measure from button screw hole to button screw hole. If other lengths are required, call for customization.

Any one poly cord	#780	\$9.95 each
Metallic gold or silver cord	#781	\$11.50 each



Army Band Cap Cord

Wear on any cap with two buttons. Be sure to add color code after item number. eg #790KG for Kelly Green. See chart at left for color codes.

Any one poly cord	#790	\$13.50 each
Metallic gold or silver cord	#791	\$16.75 each



Call for a Free Swatch Not sure about what color you need or what will match something else you already have?

Pistol/Whistle Lanyards

Fully braided lanyard in any one poly color. #400 **\$21.75** each
 Partially braided lanyard in any one poly color. #403 **\$11.25** each
 Bright poly cord lanyard, no braid, in any one color. #405 **\$12.50** each



Poly Cord

White WH	Gold GO	Cardinal CD
Black BK	Dark Gold DG	Maroon MR
Jay Blue JB	Old Gold OG	Gray GY
Infantry Blue IB	Kelly Green KG	Orange OR
Medium Blue MB	Pine Green PG	Purple PR
Royal Blue RY	Dark Green GR	Buff BU
Teal TL	Scarlet SC	Brown BW
Navy Blue NV	Dark Red DR	

METALLIC CORD

	Add \$8 for silver or gold metallic cord.	
Silver Luminette (SL) (For Shaker Knot Honor Cord 484, Shoulder Cord with Pin 486, USAF Dress 622 and USAF Honor Guard Cord 638 only)		Metallic Silver (MS)
		Metallic Gold (MG)

See page 30 for Glendale's Color Compatibility Chart



Sam Gozo, World Champion Driller

Military PT Tees

Standard short sleeve military gray physical training tee shirts in a heavyweight poly/cotton. Back of shirt is blank. Sizes S – 2X. Gray.

- | | | | |
|---------------|---------------------|--------|---------|
| Army | #2130A | Navy | #2130N |
| Air Force | #2130AF | Marine | #2130MC |
| Sizes S – XL: | \$12.95 each | | |
| Size 2X: | \$12.95 each | | |

glendale  exclusive

JROTC & ROTC PT Sweatshirts

55/45 Polyester/cotton sweatshirt. Ribbed collar, cuffs and waistband. Pill-resistant fleece.

- | | | | |
|-------|---------------------|------|-------|
| JROTC | #2120 | ROTC | #2121 |
| S-XL | \$24.95 each | | |
| 2X | \$24.95 each | | |

JROTC & ROTC Tee Shirts

Short sleeve tees in a heavyweight, preshrunk cotton/poly blend by Jerzees. Ribbed collar, shoulder-to-shoulder taping and double-needle hem for durability.

- | | | | |
|-------|---------------------|------|-------|
| JROTC | #2124 | ROTC | #2125 |
| M-XL | \$12.95 each | | |
| 2X | \$12.95 each | | |

JROTC & ROTC PT Sweatpants

50/50 Cotton/polyester sweatpants. Tough double-needle stitched covered elastic waistband. No side seams. Elastic cuff at ankle. Pill-resistant fleece; inside drawcord for right fit.

- | | | | |
|-------|---------------------|------|-------|
| JROTC | #2122 | ROTC | #2123 |
| S-XL | \$24.95 each | | |
| 2X | \$24.95 each | | |



MARCHON

A Clothing Line for All Cadets
Is available exclusively at
www.paradestore.com



Shut Up and Drill Tees

Forget polite, let everyone know you mean business! Seamless body with set in sleeves. Pre-shrunk. 100% cotton. Back of shirt is blank. Sizes S – XL

- | | | |
|-----------------------|---------|---------------------|
| Black Tee, gray print | #2135 | \$21.95 each |
| Black Tee, red print | #2135RD | \$21.95 each |
| Black Tee, gold print | #2135GO | \$21.95 each |

Shut Up and Drill Sweatshirt

Our most popular tee shirt is also available as a sweatshirt. Back is blank. S-XL. Black.

- | | | |
|------------|-------|---------------------|
| Sweatshirt | #2141 | \$32.95 each |
|------------|-------|---------------------|





Solid Color Cotton Web Waist Belt, White with Brass Plated Roller Buckle #78L44WH

Group A:

Sold individually

- Black BK
- White WH
- Navy NV
- Royal Blue RY
- Red RD
- Buff/Khaki BU

Solid Color Cotton Web Waist Belts

Military Style: 1 1/4" width comes with roller buckle and metal tip.

To order, please include color abbreviation for clarification: e.g. #77L50NV (navy belt with brass buckle adjustable to size 50").



Cotton Web Waist Belts:

Roller Buckles available in Brass and Nickel

Quantity	Adjustable to 44"	Adjustable to 50"	Adjustable to 54"	Adjustable to 60"
----------	-------------------	-------------------	-------------------	-------------------

Brass Plated with Roller Buckle and Tip

Each (Group A only)	#77L44 \$4.25	#77L50 \$4.50	#77L54 \$4.75	#77L60 \$4.95
Dozen (Group B only)	#77L44 \$51.00	#77L50 \$54.00	#77L54 \$57.00	#77L60 \$59.40

Belt with Nickel Roller Buckle and Tip:

Each (Group A only)	#79L44 \$4.25	#79L50 \$4.50	#79L54 \$4.75	#79L60 \$4.95
Dozen (Group B only)	#79L44 \$51.00	#79L50 \$54.00	#79L54 \$57.00	#79L60 \$59.40

Black Belt with Black Open Face Buckle and Tip:

Dozen (Group B only)	#90L44DZ \$45.50	#90L50DZ \$47.75	#90L54DZ \$49.50	#90L60DZ \$52.50
----------------------	----------------------------	----------------------------	----------------------------	----------------------------

Group B:

Sold by dozens only

- Gray GY
- Maroon MR
- Hunter Green HG
- Olive Drab OD
- Brown BW
- Natural NT





Army Combat Uniform (ACU) Digital Desert Camo Reversible

Camo Cotton Web Waist Belts

Military Style: 1 1/4" wide with black roller buckle and metal tip.



Camo belts Sold individually only				
Adjustable to:	44"	50"	54"	60"
 Urban Camo	#80L44UC \$4.25	#80L50UC \$4.75	#80L54UC \$4.95	#80L60UC \$5.50
 ACU Digital Desert Camo/Tan - Reversible			#749X \$7.50	



Large Waist Buckle, Brass #178 (Front View)



Large Waist Buckle, Nickel #179 (Front View)



Large Waist Buckle, Brass #178 (Side View)



Large Waist Buckle #179 (Rear View)

Large Waist Buckles

Fit easily on the vertical pieces of Pistol Belts and MP Belts with hook-and-eye closures as shown.

Not engraved

Brass, 2 1/2" x 3 1/2"	#178	\$23.75 each
Nickel, 2 1/2" x 3 1/2"	#179	\$23.75 each

Engraved (Submit customized engraving in writing. Two lines. 12 characters total.)

Brass, 2 1/2" x 3 1/2"	#178E	\$33.75 each
Nickel, 2 1/2" x 3 1/2"	#179E	\$33.75 each

Buckle Bag

Soft gray buckle bag with drawstring protects your buckle's polished finish. 4" x 5 1/2" Bag #199 **\$1.95** each



Open Face Buckle, Anodized Brass #8169



Black Belt with Black Open Face Buckle and Tip #90L see chart for sizes.



Roller Buckle, Brass plated #19



Open Face Buckle, Black #39



Roller Buckle, Black #20



Roller Buckle, Nickel plated #18

Buckles for 1 1/4" Web Waist Belts

Roller Buckle 1 3/8" wide (regulation type):

Brass-plated	#19	\$1.95 each
Nickel-plated	#18	\$2.75 each
Black	#20	\$2.75 each

Open Face Buckle 1 3/8" wide:

Brass plain	#8167	\$9.25 each
Brass anodized	#8169	\$17.95 each
Black	#39	\$3.25 each

Belt tips to match above buckles:

Brass-plated	#40B	\$1.50 each
Nickel	#40N	\$1.50 each
Black	#40BK	\$1.50 each



 = PERMANENT SHINE. No polish! Gently wipe with clean, soft cloth.

Belts

Heavy Weight, Black #174

CUSTOMER FAVORITE!



Heavy Weight, AF Blue #173



Heavy Weight, White #170



2" Heavyweight canvas webbing

Heavy Weight, OD #176



Parade Belts

2 1/4" heavyweight cotton webbing – with or without eyelets – with large waist buckle and four keepers, adjustable to 44" and 52" length. Made in U.S.A. to military specifications.



Parade Belts

Color	Hardware	Eyelets	Adjustable to 44"	Adjustable to 52"
#159 AF Blue	Brass	Eyelets	#158 \$56.75	#158X \$58.95
		No eyelets	#159 \$56.75	#159X \$58.95
	Nickel	Eyelets	#160 \$56.75	#160X \$58.95
		No eyelets	#161 \$56.75	#161X \$58.95
#150 White	Brass	Eyelets	#150 \$56.75	#150X \$58.95
		No eyelets	#151 \$56.75	#151X \$58.95
	Nickel	Eyelets	#152 \$56.75	#152X \$58.95
		No eyelets	#153 \$56.75	#153X \$58.95
#156 Black	Brass	Eyelets	#154 \$56.75	#154X \$58.95
		No eyelets	#155 \$56.75	#155X \$58.95
	Nickel	Eyelets	#156 \$56.75	#156X \$58.95
		No eyelets	#157 \$56.75	#157X \$58.95
#162 Olive Drab	Brass	Eyelets	#162 \$56.75	#162X \$58.95
		No eyelets	#163 \$56.75	#163X \$58.95
	Nickel	Eyelets	#164 \$56.75	#164X \$58.95
		No eyelets	#165 \$56.75	#165X \$58.95

Parade Buckle only 2 1/2" x 3 1/2"

Brass #166 \$24.95 each

Nickel #167 \$24.95 each

Keepers only 2 1/4" x 3/4"

Brass #168 \$11.95 pair

Nickel #169 \$11.95 pair

Heavy Weight Pistol Belts

Sturdy 2" heavy weight canvas pistol belts adjust for a perfect fit and will last until the final reveille. Choose from 2 sizes, 4 colors and 2 metals — brass or nickel — for hardware.

Heavy Weight Pistol Belts			
Color	Hardware	Adjustable to 44"	Adjustable to 52"
Black	Brass	#174 \$21.25	#174X \$24.50
	Nickel	#175 \$21.25	#175X \$24.50
AF Blue	Brass	#146 \$21.25	#146X \$24.50
	Nickel	#173 \$21.25	#173X \$24.50
White	Brass	#170 \$21.25	#170X \$24.50
	Nickel	#172 \$21.25	#172X \$24.50
Olive Drab	Brass	#176 \$21.25	#176X \$24.50
	Nickel	#177 \$21.25	#177X \$24.50



Medium Weight Pistol Belts

2" Medium weight canvas webbing, black hardware, adjustable to 38".

Camouflage	#4229	\$15.95 each
Black	#4219	\$7.95 each
White	#4226	\$7.95 each
OD	#4227	\$7.95 each

Medium Weight, Camo #4229

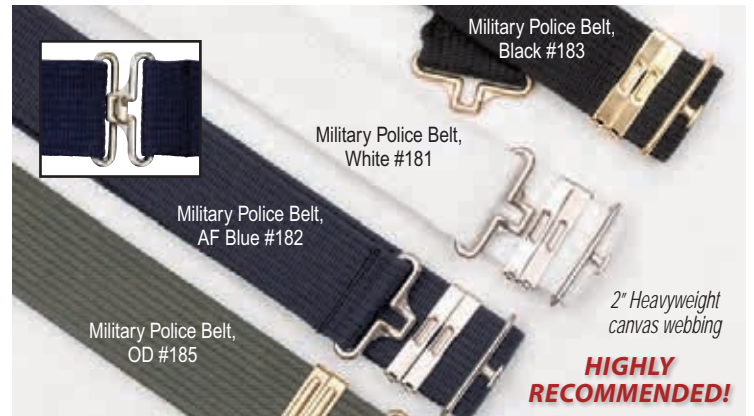
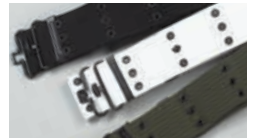

Military Police Belt, Black #183

Military Police Belt, White #181

Military Police Belt, AF Blue #182

Military Police Belt, OD #185

2" Heavyweight canvas webbing

HIGHLY RECOMMENDED!

Military Police Belts

Heavy-duty military police belts in 2" heavyweight canvas webbing adjust to fit, come in 2 sizes, 4 colors, and with your choice of brass or nickel hardware.

Military Police Belts			
Color	Hardware	Adjustable to 44"	Adjustable to 52"
Black	Brass	#183 \$19.95	#183X \$23.25
	Nickel	#184 \$19.95	#184X \$23.25
White	Brass	#180 \$19.95	#180X \$23.25
	Nickel	#181 \$19.95	#181X \$23.25
AF Blue	Brass	#148 \$19.95	#148X \$23.25
	Nickel	#182 \$19.95	#182X \$23.25
Olive Drab	Brass	#185 \$19.95	#185X \$23.25
	Nickel	#186 \$19.95	#186X \$23.25



Pistol Accessories



Parade Pistol Holster
Black with Nickel
#301



Parade Pistol Holster
(back shown)
White with Nickel
#300



Parade Pistol Holsters

Premium quality leather .45 caliber cadet holster with flap and black belt prongs, hook on or slide on. Suitable for Colt or Browning pistols or replicas. See page 36 for Honor Guard Holsters.

White

Nickel hardware	#300	\$81.50 each
Brass hardware	#302	\$81.50 each

Black leather

Nickel hardware	#301	\$65.50 each
Brass hardware	#303	\$65.50 each

Black Clarino (high gloss)

Nickel hardware	#301C	\$106.25 each
Brass hardware	#303C	\$106.25 each

We can custom order left-handed holsters. Please specify.



Leather Holster Slide,
Black with Brass
#174HSL



Leather Holster Slide,
White with Nickel
#172HSL

Leather Holster Slides

White

Brass hardware	#170HSL	\$29.95 each
Nickel hardware	#172HSL	\$26.75 each

Black

Brass hardware	#174HSL	\$26.75 each
Nickel hardware	#175HSL	\$24.50 each

Black Clarino

Brass Hardware	#174HSLC	\$28.95 each
Nickel Hardware	#175HSLC	\$26.75 each

“Excellent...!! Outstanding,
HOOAH...!!”

Maj P Petit, TX

Belts: Dress



USAF Honor Guard Ceremonial Belt, Officer

Complete belt with Coat of Arms emblem on nickel buckle, plus catch and nickel keepers. Adjustable to 50".

USAF Belt, Officer #8157 **\$109.75** each

USAF Honor Guard Ceremonial Belt, Enlisted

Complete belt with Hap Arnold emblem on nickel buckle, plus catch and nickel keepers. Adjustable to 50".

USAF Belt, Enlisted #8172 **\$109.75** each



Army Ceremonial Belt

Complete belt with Coat of Arms emblem on gold-plated buckle, plus catch and lace keepers. Adjustable to 50".

Army Belt #8151 **\$89.95** each



USAF Honor Guard Belt, Officer
#8157



USAF Honor Guard Ceremonial Belt, Enlisted #8172

Army Ceremonial Belt
#8151



= PERMANENT SHINE. No polish!
Gently wipe with clean, soft cloth.

USMC Dress Buckle gilt emblem
#8164



USMC Belts & Buckles

USMC Dress Buckle only, no emblem, 2" x 3".
#8163 **\$49.95** each

USMC Dress Buckle only, gilt emblem, 2" x 3".
#8164 **\$53.95** each



USMC Cotton
Web Khaki Belt
#8168

USMC cotton web khaki belt — 1 1/4" wide, 44" long with open, solid brass, gold-plated and hand-polished buckle. Government spec.
#8168 **\$19.95** each

Sam Browne belts are also available with and without shoulder straps



Thumb break Holster Clarino #511

Thumb break Holster Basket Weave #511BW

Holster (back view)

Thumb Break Holster

Since its invention in 1979, the Thumb Break has become a favorite of law enforcement. Honor Guards like the Thumb Break for its clean lines and have made it a favorite on parade routes as well. Made from the same top grain leather as our Sam Browne gear. Available in both Clarino and Basket Weave.

- Clarino (High Gloss) #511 \$169.95 each
- Basket Weave #511BW \$169.95 each

Ceremonial loop-style holsters without eyelets and prongs are available as a custom order for all large frame automatics and 4" revolvers. Specify type of pistol, whether belt prongs or loop is required and if you prefer brass or nickel snaps.



Half-lined Sam Browne Waist Belt Plain Black #204BK.

Sam Browne Belt Buckles

Brass or nickel finish in solid brass.

- Brass #210B \$20.95 each
- Nickel #210N \$20.95 each



Brass

Nickel

Basket Weave Pattern



Thumb break Holster Basket Weave #511BW

Round Bottom Cuff Case

Complete Basket Weave Belt with right Shoulder Strap #204RBW (Individual accessories may be purchased separately)



Break-Away Clips

Break-Away Clips for Sam Browne Belts

Stay safe! These two black metal clips attach to each end of a Sam Browne strap and the D-rings, so the strap breaks away if grabbed by an assailant.

- Break-Away Clips #211BAC \$23.25 each



Round Bottom Cuff Case



Double Magazine Pouch



Holster (back view)



Holster fits most automatics

Sam Browne Accessories					
	Color Hardware	Round Bottom Cuff Case	Double Magazine Pouch		Honor Guard Holster
			9mm	.40/.45 Cal	
Plain Black	Brass	#231BBK \$28.75	#232BBK \$49.95	#332BBK40 \$53.25	NA
	Nickel	#231NBK \$28.75	#232NBK \$49.95	#332NBK40 \$53.25	NA
Clarino (High Gloss), Black	Brass	#231BC \$45.25	#232BC \$56.75	#332BC40 \$62.50	#501 \$109.95
	Nickel	#231NC \$45.25	#232NC \$56.75	#332NC40 \$62.50	#503 \$109.95
Basket Weave Black	Brass	#231BBW \$37.75	#232BBW \$51.95	NA	#501BW \$109.95
	Nickel	#231NBW \$37.75	#232NBW \$51.95	NA	#503BW \$109.95

Order Left Shoulder Strap for right hand pistol draw.

Complete Plain Black Belt with right Shoulder Strap #604RBK
(Individual accessories may be purchased separately)

Right shoulder strap for left hand pistol draw or right hand saber draw.

Sliding "D" Rings

Leather Keepers

Belt Buckle



Dan Foley
Wyandotte (MI)
Police
Honor Guard

Sam Browne Belts and Accessories 

So how did this classic duty belt get its name? British General Sir Samuel Browne (1824-1901) designed it after his left arm was severed during battle in India; the strap helped stabilize the belt for the one-handed drawing of a saber. Our Sam Brownes are made of top grain leather, 2 1/4" wide with panel stitching for beauty and durability. Plain black waist belts and shoulder straps are available half-lined, and fully lined with top and bottom stitching. Clarino (high gloss) belts and straps are fully lined with top and bottom stitching. The "D" rings on shoulder straps are sewn into belt when ordered together; if you buy the belt only, then later decide to add a shoulder strap, sliding "D" rings will be required to attach strap to belt. When selecting your size, remember to add at least 2" if the belt will be worn over a jacket. **Shoulder straps are made in proportion to belt size. When ordering shoulder straps separately, order by length.** If you need assistance in belt or strap measurements, please call, or visit www.paradestore.com/SamBrowne. Belts and straps are custom-made. Returns will be subject to a 15% restocking charge.

Sam Browne Belts												
Color	Hardware	Complete Half-lined Belt w/ Right Shoulder Strap	Complete Half-lined Belt w/ Left Shoulder Strap	Complete Fully-lined Belt w/ Right Shoulder Strap	Complete Fully-lined Belt w/ Left Shoulder Strap	Sliding "D" Rings	Half-lined Waist Belt 28"-44"	Fully-lined Waist Belt 28"-44"	Shoulder Strap 33"-50"	1/2" Leather Keeper (each)	1" Leather Keeper (each)	1 1/4" Leather Keeper (each)
Plain Black	Brass	#204RBK \$93.75	#204LBK \$93.75	#604RBK \$114.75	#604LBK \$114.75	#209BBK \$18.50 pair	#204BK \$72.75	#604BK \$81.95	#211BBK \$48.75	#212BBK \$5.50	#213BBK \$7.95	#214BBK \$9.95
	Nickel	#205RBK \$93.75	#205LBK \$93.75	#605RBK \$114.75	#605LBK \$114.75	#209NBK \$18.50 pair	#205BK \$72.75	#605BK \$81.95	#211NBK \$48.75	#212NBK \$5.50	#213NBK \$7.95	#214NBK \$9.95
Clarino (High Gloss), Black	Brass	NA	NA	#204RC \$126.25	#204LC \$126.25	#209BC \$22.95 pair	NA	#204C \$88.75	#211BC \$54.25	#212BC \$7.95	#213BC \$12.95	#214BC \$14.95
	Nickel	NA	NA	#205RC \$126.25	#205LC \$126.25	#209NC \$22.95 pair	NA	#205C \$88.75	#211NC \$54.25	#212NC \$7.95	#213NC \$12.95	#214NC \$14.95
Basket Weave Black	Brass	NA	NA	#204RBW \$119.95	#204LBW \$119.95	#209BBW \$20.95 pair	NA	#204BW \$84.95	#211BBW \$51.95	#212BBW \$6.95	#213BBW \$8.95	#214BBW \$11.95
	Nickel	NA	NA	#205RBW \$119.95	#205LBW \$119.95	#209NBW \$20.95 pair	NA	#205BW \$84.95	#211NBW \$51.95	#212NBW \$6.95	#213NBW \$8.95	#214NBW \$11.95

Prices shown are for even waist sizes 28-44; for sizes 46 and above, please call for pricing or order online. Add belt size when ordering.

Email customerservice@glendale.com • Order online at www.glendale.com

Spats and Leggings



Snap Leggings
#200E
M: Men's shoe sizes up to 7½
L: Men's shoe sizes 8 and above



Vinyl Spats
#110E

Vinyl Snap Leggings

Top-quality 9" leggings in a wipe-clean off-white vinyl with a fabric lining for comfort. White metal snaps on elastic ensure a proper fit.

S/M or L/XL #200E **\$34.95** pair

Vinyl Spats

Top-quality 6" spats in a wipe-clean off-white vinyl have a fabric lining for comfort. White metal snaps on elastic ensure proper fit. S/M: Men's shoe sizes up to 7½; L/XL: Men's shoe sizes 8 and above.

S/M or L/XL #110E **\$19.95** pair

Heel and Edge Color

Angelus Roll Call Military Grade Edge Dressing

Used by the Old Guard for soles and edges! Black. 4 oz. Use it with the Honor Guard High Gloss Instant "Spit-Shine," sold above. Military Grade Edge Dressing #3441 **\$10.75** each

Roll Call Edge Dressing #3441



Honor Guard Heel & Sole Edge Color Renew #3413



Honor Guard Heel & Sole Edge Color Renew

Kiwi's® updated version of the black edge dressing previously available — but without the high gloss shine. Water resistant, it renews the factory finish of heels and soles. Plastic bottle and sponge applicator. 2.5 fl. oz. Color Renew #3413 **\$7.95** each

Color Renew #3413 **\$7.95** each



Blousers

Olive Drab #110D



Foliage Green #11FG



Black #11BK



Desert Tan #11DS



Blousing Garters

Hook-on fastener.

Olive Drab #110D	\$2.25 pair	Tan #11DS	\$2.25 pair
Black #11BK	\$2.25 pair	Foliage Green #11FG	\$2.25 pair

T.A.B.S.® Boot Blousers

A sturdy 2"-wide woven elastic band with hook and loop closure end tabs for military personnel or sportsmen. Wear them inside or outside your boots.

Black #16BK	\$4.95 pair	Olive Drab #16OD	\$4.95 pair
Desert Tan #16DS	\$4.95 pair	ACU Foliage Green #16FG	\$4.95 pair

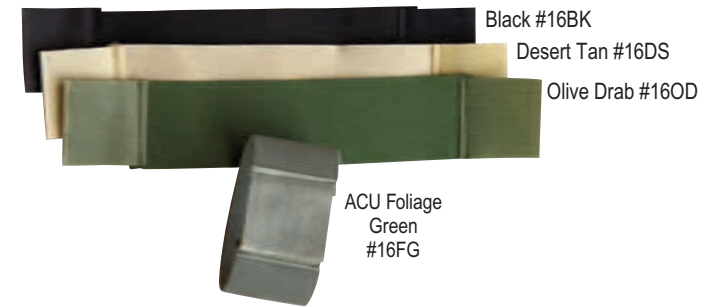

ACU Foliage Green #16FG

Leather Polish and Color

Honor Guard High Gloss Instant "Spit-Shine"

When a real high gloss shine is what you want, this is the product you need! Made by Kiwi. Black. 2.5 oz. Use this along with the Angelus Roll Call Military Grade Edge Dressing.

Instant "Spit-Shine" #3412 **\$7.95** each

Honor Guard Instant "Spit Shine" #3412



Parade Gloss Wax

Kiwi® Parade Gloss paste wax guarantees a brilliant, long-lasting and water-repellent shine. 1½ oz.

Parade Gloss Wax #3414 **\$7.95** each



Parade Gloss Wax #3414

Laces

Nylon Boot Laces

No-fray nylon laces in 4 colors, 72".

Gold #603G	\$2.95 pair
Black #603B	\$2.95 pair
White #603W	\$2.95 pair
Red #603R	\$2.95 pair



Military Boot Laces

For use with desert or mojave military boots. Tan nylon laces meet government specifications, 72".

Boot laces, tan #7441 **\$2.95** pair



Leather Cleaner and Conditioner

Leather Luster™

A liquid polish used by law enforcement, fire and rescue, military, sports officials, and medical personnel to give leather boots, shoes, gun belts, and other leather articles a brilliant, high gloss shine. It will not crack, peel or harm leather in any way. 4 oz. can.

Leather Luster™ #3443 **\$17.95** each



Leather Luster #3443

Rough-Out Leather Cleaner & Conditioner



Keep rough-out leather looking clean and cared for, and prevent cracking and breaking. Built-in scrub topper; wipe clean. For best results, follow by protecting with Rough-Out Leather Color Renew & Protector #3435 or #3436 (available at paradestore.com).

4 oz. plastic bottle #3434 **\$8.95** each



Rough-Out Leather Cleaner & Conditioner #3434



NEW! 9" Tactical Boots

The cushioning of a running shoe and the traditional support of military boot combine to set a new all-day comfort standard. The suede leather and nylon mesh uppers are backed by a moisture-wicking lining to help keep your feet dry. Easy on/off non-rusting YKK® side zipper has a hook-n-loop zipper strap that secures and silences the zipper fob. D-Ring top laces for a snug fit. EVA midsoles for cushioning. Steel shank for added support. Padded leather collar. Removable comfort cushion footbed Slip-resistant dura-grip outsoles. Note: Some sizes are subject to availability. Color: Desert Tan. 8" height. Whole and half sizes 7-11, 12 Medium.

Standard Width #3475S **\$109.95** pair

High Gloss Uniform Oxford

Mirror-finish black Oxfords spiff up your step and won't break your wallet. The tough, slip-resistant polyurethane outer sole ensures years of drilling; lightweight lining and removable cushion insole promise comfort. Manmade materials; steel shank. Cheater Bars and Heel Taps not recommended for these shoes. Men's Sizes: Whole: 3-15; Half: 4.5-12.5; Wide in Whole: 6-15, Half: 7.5-11.5. Women order two sizes down.

Standard Width #3455S **\$63.75** pair
Wide Width #3455W **\$63.75** pair

Women order 2 sizes down.

Heel Taps and Cheaters

Civilian Guard Cheater Bars #3426



Civilian Guard Cheater Bars

These new and improved cheaters — in size, position of the screw holes, and the screws themselves — are designed to be more compatible with the men's and women's shoes worn by civilian honor guards. The black oxidized finish is rust resistant inside and out. 4" x 7/8". Two bars and four screws per set.

Civilian Guard Cheater Bars #3426 **\$13.50** set



Old Guard Cheater Bars #3423



Old Guard Cheater Bars

Worn on the inside of shoe heels to emphasize the "click" of the heels. Silver finish, 3 1/2" x 1". Two bars and four screws per set.

Old Guard Cheaters #3423

\$13.50 set



Honor Guard Horseshoe Heel Taps

These metal taps are sized for the shoe heel. Two in a set with extra nails. Please measure shoe heel, as there is no standardization in shoe size and heel size.

2 7/8" W x 3 1/8" H	#3421S	\$10.95 set
2 7/8" W x 3 1/4" H	#3421M	\$10.95 set
3 1/8" W x 3 3/8" H	#3421L	\$10.95 set
3 1/4" W x 3 9/16" H	#3421XL	\$10.95 set



COMFORTABLE AND AFFORDABLE!

High Gloss Uniform Oxford #3455S

Uniform Accessories



Buttons to shirt to keep ties straight

Designed to break away if grabbed by a suspect.

Clip-on Black, 18" #3045

Velcro Dark Navy, 20" #3050

Quick Release Uniform Ties

Stay safe while looking sharp! Designed to break away if grabbed by a suspect, these ties also have a buttonhole feature to keep them straight. Simply slide the narrow end of the tie through the loop and button to the shirt. Each is 3" wide with a permanent knot. Available in 18" or 20" length in dark navy or black. Made of polyester in the U.S.

Clip-on

Dark Navy, 18"	#3044	\$9.95 each
Dark Navy, 20"	#3046	\$9.95 each
Black, 18"	#3045	\$9.95 each
Black, 20"	#3047	\$9.95 each

Velcro® closure

Dark Navy, 18"	#3048	\$12.95 each
Dark Navy, 20"	#3050	\$12.95 each
Black, 18"	#3049	\$12.95 each
Black, 20"	#3051	\$12.95 each



Female Neck Tab

Velcro closure, poly-cotton blend. Black. Made in the USA

Black	#3053	\$13.95 each
Navy	#3054	\$12.50 each

Rain cover with visor sold on page 48.



Uniform Poncho

Heavy duty, opaque vinyl poncho — foul weather gear for parades and competitions — keeps your uniform dry and protected. Electronically sealed seams, double snaps on sides, permanent hood; individually packed in snap pouch. 50" x 80".

Poncho (Not Shown) #490 \$5.50 each



Shirt Tailor #435

Tough, thick rubber



Shirt Garters, White #437WH

Shirt Garters

Keep socks up and shirt down! 4 garters per set. Attach fasteners to socks, front and back, and front and back of shirt tail. No metal touches body. Slide adjustment for comfortable tension. One size fits all.

Black	#437BK	\$12.50 set
White	#437WH	\$12.50 set



Super Shirt Garters, #443BK

Super Shirt Stay Garters

Our Super Shirt Stay Garters ensure you always look parade-sharp. What's super? The No-Slip Clip, which attaches firmly to shirt while elastic stirrup strap slips under foot. Black only.

#443BK Black \$24.95 pair.



Stirrup Shirt Stays, #440BK

Stirrup Shirt Stays

Make sure your shirt stays tucked in smartly with stirrups. The elastic strap encircles your foot; the adjustable garters attach to your shirt. Black only.

Stirrup Shirt Stays #440BK \$13.75 pair



Military Y-Style Shirt Stay #441BK

Military Y-Style Shirt Stay

The single clip attaches to sock; the double clip attaches to shirt tail. 3/4" black elastic with black metal adjusters.

#441BK Black \$11.50 pair

Shirt Tailor

Look professional and parade-ready every time with our Shirt Tailor. Wear it over your shirttail and inside your trousers just below the waistband to keep your shirt neatly tucked in and you looking sharp no matter the drill. Thick rubber and a reinforced end offer improved durability; light weight (6 oz) makes it day-long comfortable under uniform or casual clothes. 1 1/4" wide. One size fits most. 44" stretches to 46"; trim excess to fit. Gray or white.

Shirt Tailor, gray	#435	\$14.25 each
Shirt Tailor, white	#436	\$14.25 each



Non-slip Shirt Holders 4pc set

Non-slip locking clamps help avoid those awkward moments caused by clasps coming loose.

Attach the clamps to your shirt and sock (front and back); use the adjustable clips to find the most comfortable fit. All four straps should be used to maintain a professional, dry-cleaned appearance.

Wash with warm, soapy water, air dry.

Black #438BK \$16.95 set



Non-slip locking clamps provide a secure grip on socks and shirt.

Shirt Lock is a great alternative to stays or suspenders!

Shirt Lock™ 1" #445



Shirt Lock™ 1 1/2" #446



Shirt Lock™

This undergarment belt was designed for uniformed officers in police, fire, military, and homeland security services. It's a reliable alternative to shirt stays, rubber and flex belts, and even suspenders. Made of high quality lightweight nylon hook-on-hook material that grips both the fabric of your shirt and your pants. Wear it around your waist just below the belt line of your pants — it won't roll — to hold uniform, dress or sport shirts. Includes a decorative anodized copper tin that helps maintain the Shirt Lock's shape and keep it lint free between uses.

1" width to 38"	#445	\$19.95 each
1" width to 48"	#445X	\$20.95 each
1 1/2" width to 38"	#446	\$21.95 each
1 1/2" width to 48"	#446X	\$22.95 each
1 1/2" width to 58"	#446XX	\$25.25 each

Whistles



American Classic™ Whistle, Brass #817

Bosun's Whistle #812

American Classic™ Whistle, Nickel #818 shown with Cushion Cover #819

Whistles



American Classic™ Whistle:

Brass #817 **\$8.75** each
 Nickel #818 **\$8.75** each

Cushion/Cover for American Classic™ Whistle,
 Black #819 **\$2.50** each

Bosun's Whistle

Brass-plated boating and sailing whistle is a replica of those still in use by boatswains on Royal Navy ships. Comes with chain as shown. (This whistle not made in the U.S.)

Bosun's Whistle #812 **\$12.50** each

Chains and Holder



#813

#814

#126

Chains

Snake Chain with button hook:

Gold plated, 20" #813 **\$9.95** each
 Nickel plated, 20" #814 **\$9.95** each

Police Whistle Chain

Spring clip at each end.
 Chrome #126 **\$8.95** each



Bar and Hook Whistle Holder #820

Bar and Hook Whistle Holder

Gold plated #820 **\$5.95** each
 Nickel plated #821 **\$5.95** each

Toggles and Extenders



Button Toggle (Actual Size) #3430

CUSTOMER FAVORITE!

Button Toggle

Holds shank of button firmly in place. Nickel 3/4" long
 Button Toggle #3430 **\$.50** each

Collar Extender

Add up to one-half size to your shirt collar! Loop extender over your collar button — it stays hidden behind your tie. Rust-proof.



Collar Extender #432

Collar Extender #432 **\$4.75** each

Cleaning & Polishing



Giant Lint Roller #9276

Giant Lint Pick-Up Roller

Handy oversize roller makes a spotless appearance easy. Use before each competition or performance. 10" tall; 60 extra-large sheets—more than 36 feet of roller material!

Giant Lint Roller #9276 **\$9.95** each

Tip: Dust, lint and dandruff can make a crisp uniform look shabby. Keep your uniform in tip top condition with a lint roller.



Polishing Cloth #234

Polishing Cloth

Blitz 1+1 Polishing and Buffing Cloth removes tarnish, cleans, and polishes.

Polishing Cloth #234 **\$5.95** each

Nameplates

U.S. Army #251AE



U.S. Air Force #251AFE



U.S. Navy #251NE



U.S. Marine Corps #251MCE



Military Plastic Nameplates



Made of a shatterproof and mar-resistant plastic with a non-glare smooth matte finish, nameplates have two military clutches on the reverse side. Plastic, rotary engraved. 15 letters max. Submit customized engraving in writing. Nameplates will be engraved with last name only in upper case.

Army nameplate: 1" x 3"

White letters on black, #251AE **\$3.25** each

Air Force nameplate: 5/8" x 3 3/16"

White letters on blue, #251AFE **\$3.25** each

Navy nameplate: 3/4" x 3"

White letters on black, #251NE **\$3.25** each

Marine nameplate: 5/8" x 3"

White letters on black, #251MCE **\$3.25** each

Any of the above, Please note branch of service.

Blank. #251B **\$2.75** each



U.S. Air Force Metal #252E

USAF Metal Nameplate

Dress Uniform engraved metal nameplate, 3/4" x 3". Nameplates will be engraved with last name only in upper case.

USAF Metal Nameplate #252E **\$10.95** each



Metal Nameplate

Engraved metal nameplate with red lettering, 3/4" x 3"

Brushed Silver #257E **\$10.95** each
 Brushed Gold #258E **\$10.95** each

More Firefighter Nameplates available at www.paradestore.com! Type "Red Nameplates" into the search box.



Commando Beret
#4051

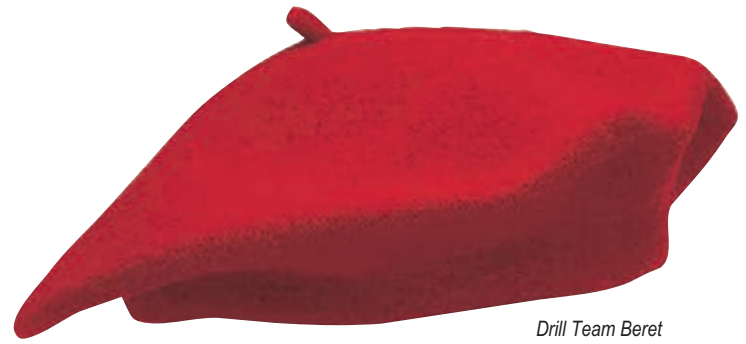

Drill Team Beret
#4024

Commando Berets

Wool with polyester lining and black vinyl sweatband; adjustable drawstring for perfect size fit. "Pip" on top is clipped. XS S M L XL or give hat size. See chart below for color choices.

- No badge stay. #4051 **\$27.95** each
- With badge stay. Please indicate placement: center, left, or right. #4051A **\$29.95** each

The badge stay in the 4051A berets is sewn to order.



Drill Team Berets

Wool with "pip" on top, no sweatband; unlined. One size — 10-inch adjustable to head size, stretches to fit most. See chart below for color choices.

- No badge stay. #4024 **\$19.95** each
- With badge stay. #4024A **\$21.95** each

The badge stay in the 4024A berets is sewn to order and may limit stretching capability.



See page 45 for Glendale's Color Compatibility Chart to match Bib Scarves, Berets and Cords

Please Note: We try to match dye lots, but manufacturers do not always make that possible.

Not sure about what color you need or what will match something else you already have?



Special Forces Beret Flashes

The Special Forces flashes shown at left are available with no minimum order. All flashes are 1 3/4" x 2". Order any flash at left by writing order number #4081 + number shown on flash.

- #4081 **\$3.95** each

Patch Attach

Here's a quick and easy way to bond patches onto berets, jackets, and most fabrics without sewing! A hot iron makes it permanent and washable or dry cleanable. It's also non-toxic. Use it for beret flashes, military and police patches, varsity letters, and school patches. Patch Attach is not recommended for satins, nylon, leather, or fabrics that are thin, sheer, padded, insulated, or so delicate they cannot withstand heat. 1 oz.

- #3410 **\$7.95** each

Need a beret flash made to your specifications? Simply go to www.paradestore.com, and use our easy design template. You can also send a sample or detailed sketch. Turn to page 93 for more information. Minimum order for custom flashes is 50. Price quotation will be sent on inquiry.





Armed Forces Beret #4063

Armed Forces Berets

Military wool beret without the "pip" on top. Available with or without polyester lining. Adjustable drawstring fit with left badge stay and leather sweatband. XS S M L XL or give hat size. See chart below for color choices.

- Fully lined #4062 **\$19.95** each
- White only **\$19.95** each
- Unlined #4063 **\$17.95** each
- White only **\$17.95** each

"Buying all my berets here from now on!"
A.C., TX

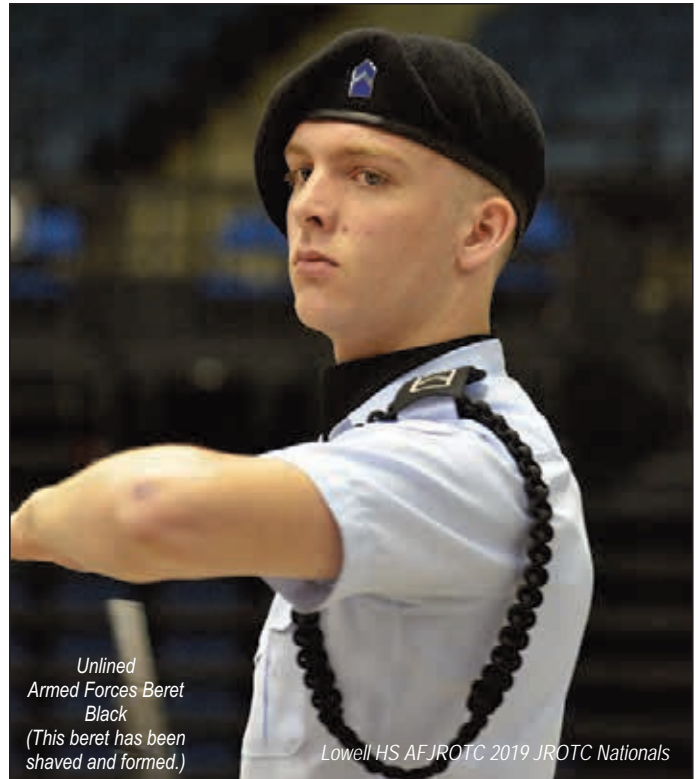

Unlined
Armed Forces Beret
Black
(This beret has been shaved and formed.)

Lowell HS AF JROTC 2019 JROTC Nationals



See page 45 for Glendale's Color Compatibility Chart to match Bib Scarves, Berets and Cords

Glendale Makes it Easy to Coordinate Berets, Bib Scarves and Cords



Brandeis HS 2019 AFJROTC Nationals

Beret Sizes and Equivalents

4062, 4063: XS - XL			4051/4051A		
6 3/4 - 6 7/8	XS	20"	6 3/4	XS	20"
7 - 7 1/8	S	21 1/8"	7	S	21 1/8"
7 1/4 - 7 3/8	M	22 3/8"	7 1/8	M	22 1/4"
7 1/2 - 7 5/8	L	23 1/2"	7 1/4	L	22 5/8"
7 3/4 - 7 7/8	XL	24 1/4"	7 3/8	XL	23"

To determine beret size: With a cloth measuring tape, measure completely around the head. Start 1" above the eyebrows and go around the largest point at the back of the head.

Instructions for cleaning wool beret:

Gently steam wool to deodorize it. Wipe the vinyl sweatband around the edges with a soft cloth and gentle cleaner. For best results, berets should be "professionally dry cleaned," which is a special cleaning process. Wool, satin, and vinyl will react differently to cleaning solvents. A competent dry cleaner can block the beret back to its original shape, if necessary. Glendale is not liable for dry cleaners' treatments.



Military Bib Scarf #015

Military Bib Scarves

Made to military specifications in the traditional tropical weave polyester, this scarf can be laundered or dry cleaned. Hook and loop closure. 19" neck measurement. Bib is 8 3/4" x 17". White, scarlet, brick red, maroon, purple, light navy, navy blue, infantry blue, teal, royal blue, academy royal, powder blue, dark green, kelly green, Glendale gold, dark gold, buff, orange, silver gray, black, charcoal, and digital camouflage. The scarf extender can be used with this scarf.

Solid or Military Bib Scarf #015 \$9.25 each
 Digital Military Bib Scarf #015DC \$9.25 each

White WH	Purple PR	Teal TL	Dark Green GR	Buff BU	Black BK
Scarlet SC	Light Navy LN	Royal Blue RY	Kelly Green KG	Orange OR	Digital Camo DC
Brick Red BR	Navy Blue NV	Academy Royal AR	Glendale Gold GG	Silver Gray GY	
Maroon MR	Infantry Blue IB	Powder Blue PB	Dark Gold DG	Charcoal Gray CH	

Pleated Bib Scarves

Smart pleats at the neckline distinguish this scarf, made in the traditional military tropical weave fabric that can be laundered or dry cleaned. 19" neck measurement with a hook and loop closure. Bib is 14" x 15". Available in white, scarlet, royal, navy, dark gold, Glendale gold, kelly green, and black. The scarf extender can be used with this pleated scarf.

Pleated Bib Scarves #020 \$10.50 each

White WH	Navy Blue NV	Kelly Green KG
Scarlet SC	Dark Gold DG	Black BK
Royal Blue RY	Glendale Gold GG	



Pleated Bib Scarf #020

See page 45 for Glendale's Color Compatibility Chart to match Bib Scarves, Berets and Cords

Call for a Free Swatch



Smooth-as-Silk Bib Scarf #014

Military Bib Scarf (Shown at left) #015

Smooth-as-Silk Bib Scarves

Soft polyester feels great against skin and can be laundered or dry cleaned. Scarves are already turned over once at the neckline and tacked down at the sides. Hook and loop closure. 19" neck measurement. Bib is 8 1/4" x 15". Available in awareness pink, white, scarlet, royal blue, navy blue, powder blue, dark orange, gold, maroon, and black.

Smooth-as-Silk Bib Scarves #014 \$9.95 each

White WH	Scarlet SC	Dark Orange DO
Maroon MR	Royal Blue RY	Navy Blue NV
Powder Blue PB	Gold GO	Black BK

Cold Weather Fleece Bib Scarf #011



Thin enough to look crisp and thick enough to keep you warm

glendale exclusive

Winter Weight Fleece Bib Scarves

When the temperature starts dropping but honor duty calls, switch to this fleece scarf. The design is similar to a military bib scarf – but so much warmer! This machine washable fleece won't pill. Bib is 9 1/2" x 19". Available in black, dark gold, navy, royal blue, scarlet and white.

Fleece Bib Scarves #011 \$11.25 each

White WH	Scarlet SC	Dark Gold DG
Royal Blue RY	Navy Blue NV	Black BK

Military Bib Scarf Extenders

For extra comfort, extend your neck band up to 4". Scarf Extenders can be used on all Glendale bib scarves, but fabric is the same as the #015 and #020 scarves. Colors shown above. Specify color code after order number. 3/4" wide by 4" with hook and loop closures at both ends.

Military Bib Scarf Extenders #018 \$2.95 each



glendale exclusive



Leader Loops

A new style loop with a hook and loop closure that allows each loop to lie flat and secure under an epaulet. In the same tropical weave polyester as the #015 and #020 Bib Scarves. Available in Glendale gold, dark green, kelly green, navy, royal, scarlet, white, orange, and black.

Leader Loops #1015 \$5.95 pair

White WH	Scarlet SC	Orange OR	Glendale Gold GG	Navy Blue NV	Royal Blue RY
Dark Green GR	Kelly Green KG	Black BK			

glendale exclusive

Comfort Meets Salute-Worthy Style

“Amazing delivery, faster than anything else. Will recommend to my fellow LAPD cadets and let them know about Glendale.”

J.N., CA



White Plastic Helmet #761

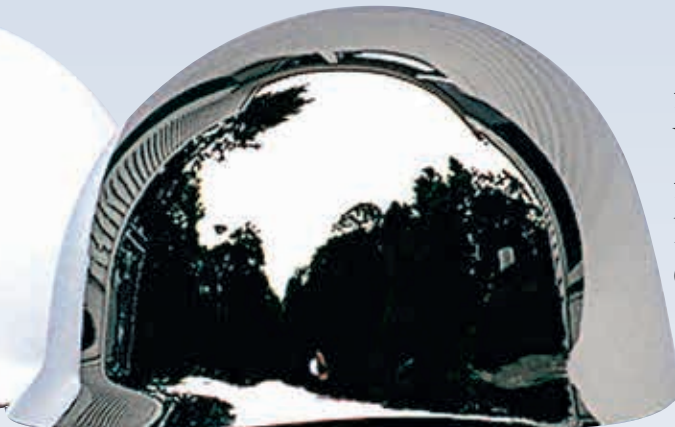

Chrome-plated Plastic Helmet #762

Parade Helmets

White molded plastic helmet liner has an adjustable headband and 3/4" white web nylon adjustable chin strap. Shiny finish.

White Plastic Helmet #761 **\$33.95** each

Brilliant and reflective chrome-plated molded plastic helmet with adjustable headband and 3/4" white web nylon adjustable chin strap.

Chrome-plated Plastic Helmet #762 **\$56.95** each

Glendale's Color Compatibility Chart

If you're trying to compare scarves, berets and shoulder cords in the same color, the most compatible matches (barring any changes in manufacturers' colors or dye lots) are indicated in the following chart. Color swatches are available for scarves, berets and cords.

BIB SCARVES	BERETS	CORDS
White 011, 014, 015, 020	—	White
—	White 4024, 4051	White
Scarlet 011, 014, 015, 020	Scarlet 4024, 4051, 4062, 4063 Dark Red 4062, 4063	Scarlet
Dark Orange 014	Orange 4062, 4063	Orange
Maroon 014, 015	Maroon 4024, 4051, 4062, 4063	Maroon
Purple 015	Purple 4024, 4051	Purple
Navy Blue 011, 014, 015, 020	Navy Blue 4062, 4063	—
Light Navy Blue 015	Navy Blue 4024, 4051	Navy Blue
Infantry Blue 015	—	Infantry Blue
Royal Blue 011, 014	Royal Blue 4024, 4051	Royal Blue
Royal Blue 011, 015, 020	Royal Blue 4062, 4063	—
Academy Royal Blue 015	Academy Royal Blue 4062, 4063	—
Teal 015	—	Teal
Dark Green 015	—	Dark Green
Kelly 015, 020	—	Kelly
Dark Gold 011, 015, 020	Gold 4024, 4051	Dark Gold
Gold 014	Gold 4024, 4051	Dark Gold
Buff 015	—	Buff
Black 011, 014, 015, 020	Black, all styles	Black
Charcoal Gray 015	Gray 4062, 4063	—
—	Kelly 4024, 4051, 4062, 4063	Pine Green



Black Strap and Cup #86

White Strap and Cup #85

glendale
exclusive

Elastic Chin Straps and Cups

This may be the most comfortable chin strap and cup you'll ever wear! It's a soft white or black elastic with a soft plastic cup for use with our #761/#762 helmets. Will fit any size chin!

White Strap and Cup #85 **\$9.95** each

Black Strap and Cup #86 **\$9.95** each

glendale
exclusive

P.S. Customers tell us it's good for service caps, and shoes, as well!



Flannel Helmet Bag #765

Flannel Helmet Bag

Protect the white helmet or the highly polished surface of your chrome helmet from scratching with this soft green flannel storage bag, created especially for Glendale. Color may vary.

Flannel Helmet Bag #765 **\$9.95** each



Collapsible Organizer
#1190

Code Alpha™

Designed for extreme use in adverse conditions, Code Alpha™ brand gear bags were developed for the Navy SEALs and military Special Operations Forces. They are constructed from the most durable materials available, packed with innovative features, and guaranteed to last.



CUSTOMER FAVORITE!

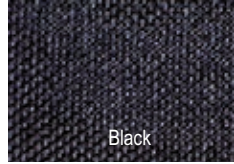

Black

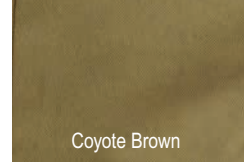

Coyote Brown

“Made in USA—Excellent!”

J.M., PA



Collapsible Organizer

A Code Alpha™ carry-all in one durable organizer! Constructed of 600 denier water-resistant polyester, this two-level bag has movable dividers. The bottom level has a ventilated mesh front door; the top lid organizer has a large mesh section for assorted gear. There are large self-healing locking zippers (lock not included). Another easy feature is the address card window and hook-and-loop strip for name tapes. When not in use, it collapses in height from 12" to 2" for easy storage. Ease of handling and stability are assured with two end carry handles and non-slip rubberized feet. Black only. 12"H x 27"L x 14"D.

Black #1190 **\$119.95 each**

Garment Covers

Step up to a travel worthy solution. These tough travelers are infinitely better than plastic garment covers. Made of 600 denier polyester with a double vinyl backing for waterproof protection. Full length zipper and a hanging loop handle. 38½"L x 24"W x 3¼"D.

Black #1142 **\$29.95 each**

Coyote Brown #1141 **\$29.95 each**



Kit Bag #1140
Coyote Brown

Kit Bags

“Pack up your troubles in your old kit bag ...” and everything else, as well, in the large main compartment with heavy duty zippers. A dust cover with snaps on the main compartment will protect 5384 cubic inches of gear; and reinforced side handles will support it. Constructed of 600 denier polyester with vinyl backing. 23½"H x 19½"L x 11¼"D.

Black #1131 **\$39.95 each**
Coyote Brown #1140 **\$39.95 each**



Coyote Brown
Garment Cover
#1141



WallyBags® Garment Bags

WallyBags® offers a wide selection of high quality garment bags, featuring the exclusive WallyLock® hanger clamping system. Your clothes won't fall to the bottom of the bag with the innovative Wally® clamp that can accept any type of hanger. No folding, rolling, or special packing skills required. Pack straight from closet to garment bag – ready for travel! Clothes stay neat and wrinkle-free.

Durable, water repellent, polyester material provides all weather protection, and is designed to withstand the wear and tear of frequent travel. Conveniently fits in the overhead bin for most airlines. Made in China. Colors: Navy, Black.

40" Garment Bags

WallyLock® clamping system holds up to 6 hangers. Soft carrying handles wrap around the trolley system of rolling luggage for effortless travel. Full length center zipper, and 3" gusset. 40"L x 22"W x 3"D

- Black #1031BK \$49.95 each
- Black, Embroidered * #1031BKE \$64.95 each

40" 2-Pocket Garment Bags

WallyLock® clamping system holds up to 6 hangers. Two pockets for packing shoes, a toiletry bag, and more. Full length center zipper, and 3" gusset. 40"L x 22"W x 3"D

- Black #1032BK \$69.95 each
- Black Embroidered* #1032BKE \$84.95 each
- Navy #1032NV \$69.95 each
- Navy Embroidered* #1032NVE \$84.95 each

45" Extra Capacity 2-Pocket Garment Bag

Larger WallyLock® clamping system holds up to 8 hangers. Two pockets for packing shoes, a toiletry bag, and more! Double side zippers open like a book for easy packing. 4" gusset. 45"L x 22"W x 4"D

- Black #1035BK \$89.95 each
- Black Embroidered* #1035BKE \$104.95 each

*40" and 45" WallyBags® can be embroidered with a personal ID of name and/or unit. Indicate one or two lines of embroidery and 25 letters per line. Embroidery colors: White, Red or Gold. Submit embroidery instructions in writing. Allow three weeks extra for embroidery.

Request a quote to add a logo to your bags.



40" Garment Bag, Navy #1031BK



Patented hanger clamping system prevents hangers and clothes from falling to the bottom of the bag. Clamping system design mark is registered in the U.S. Patent and Trademark Office.



40" 2-Pocket Garment Bag #1032BK



#1031 Garment Bag Closed



#1032 Garment Bag Closed



45" Extra Capacity WallyBag® #1035BK

45" Slim-Fit Garment Bag NEW!

The WallyLock® clamping system holds up to 6 hangers. One pocket for packing shoes or toiletry bag. Perfect for a weekend trip. Full length center zipper. Colors: Black. 45"L x 24"W.

- Black #1030BK \$39.95 each



Black Lightweight Garment Cover #1030BK

Add your name or logo!

Add an embroidered personal ID, and name to your bag for easy identification.



Add logos and emblems to your bags. No minimum quantities required. Call 1-800-653-5515 or email orders@glendale.com for a quote.

Hard-to-Find Essentials



Cap Rain Covers

Protect your cap from the elements with an easy-on  clear plastic rain cover.

- Rain cover without visor. #287 **\$5.95** each
- Rain cover with visor #489 **\$6.95** each

Campaign Hat, navy #3035 and Cords, Metallic Gold #783



Campaign Style Hat

Made of the finest imported felt available, our campaign style hats are unsurpassed for durability and flair. The opaque, triple-thick, extra-stiff 3" brim protects against harmful UV rays, while a genuine leather sweatband and 3 ventilating eyelets on sides and back help you keep your cool. Front badge eyelet. **Cap cord not included; Stratton hat straps sold separately.** Black, navy, olive drab/conservation green. Sizes 6¾ through 7⅞.

Campaign Style Hat #3035 **\$189.95** each

Campaign Hat Cords

You'll appreciate our hat cords for their color brilliance, thickness, smoothness, strength, and weight. Any quantity may be ordered in black, brown, dark gold, gold, kelly, navy, royal, scarlet, white, metallic gold, or metallic silver. For all other colors, 12 of each color is the minimum order. All colors are shown on page 31. 

- Any one poly color #782 **\$9.95** each
- Metallic gold or silver #783 **\$10.95** each

Stratton Rain Covers

Opaque vinyl rain covers custom sized for Stratton Campaign style hats. Indicate size.

- Rain Cover #3040 **\$11.95** each
- Small: 6½, 6⅝, 6¾ Large: 7¼, 7⅝, 7½
- Medium: 6⅞, 7, 7⅞ X-Large: 7⅞, 7¾, 7⅞

Uniform Poncho

Keep your uniform dry and protected with a heavy duty, opaque vinyl poncho, foul weather gear for parades and competitions. Electronically sealed seams, double snaps on sides, permanent hood; individually packed in snap pouch. 50" x 80". (Not Shown)

- Uniform Poncho #490 **\$5.50** each



Military-style Police Uniform Cap #3021

Military-style Police Uniform Caps

Midnight navy serge • Sturdy plastic inner frame • ½" black plastic front strap • Black patent leather visor with mesh band • Non-toxic cloth-backed vinyl sweatband, sewn and turned for cushioned effect to provide maximum comfort • ID pocket in top lining • Front badge eyelet plus two ventilating eyelets on each side • Gold and silver Permanent Shine cap buttons included • Made in U.S. by Bayly.

- Sizes: Small: 6⅞ - 7 21½" - 22⅞"
- Medium: 7⅞ - 7¼ 22¼" - 22⅞"
- Large: 7⅞ - 7½ 23" - 23⅝"
- XLarge: 7⅞ - 7¾ 23¼" - 24⅞"

- Military Style Uniform Caps #3021 **\$79.95** each
- Replacement Cap Buttons Gold #3021BG **\$2.95** each
- Replacement Cap Buttons Silver #3021BS **\$2.95** each

Black Grained Vinyl Trooper Hat #3125



Black Taslon Trooper Hat #3126



Trooper Hats

Made for maximum warmth. Quilted insulated lining and fold-down ½"-high pile acrylic fur-lined ear flaps. Front badge eyelet. Available in breathable, water repellent taslon style. Made in U.S. by Alboum Hat. Size chart below.

- Black grained vinyl with black four-snap chinstrap. #3125 **\$24.95** each
- Black nylon taslon with adjustable one-snap chinstrap. #3126 **\$29.95** each

Single Long Strap



2-Piece Strap



Stratton Hat Straps

Single long strap, 3/8" wide x 29", used alone or in combination with a 2-piece strap. 

- Black #3038BK **\$9.50** each
- Brown #3038BW **\$9.50** each
- Black patent #3038BKP **\$11.95** each
- 2-piece 3/8"-wide chin strap with holder used in combination with a cord or 1-piece strap.
- Black #3039BK **\$11.95** each
- Brown #3039BW **\$11.95** each
- Black patent #3039BKP **\$13.50** each

Trooper Hat Sizes and Equivalents

TO DETERMINE CAP SIZE: With a cloth measuring tape, measure completely around the head. Position the tape above the ears where you wish to wear the cap. Find your measurement below and the corresponding hat size.

Small	6⅞-7	21½"-22⅞"
Medium	7⅞-7¼	22¼"-22⅞"
Large	7⅞-7½	23"-23⅝"
XLarge	7⅞-7¾	23¼"-24⅞"

Metal Expansion Straps, Gold #3030



Metal Expansion Straps, Silver #3031

Metal Expansion Straps

For that special touch, add a metal expansion strap in gold or silver finish. Use with Military-Style Uniform Caps, AF Service Caps, and Bell Crown Caps. Expands to 11" and fits any size cap.

- Gold #3030 **\$19.95** each
- Silver #3031 **\$19.95** each



PERMANENT SHINE No polish!
Gently wipe with clean, soft cloth.



Campaign Hat Carriers

BESTSELLER

This double-duty carrier protects a campaign hat with up to a 4" brim and has a built-in hat press to keep the brim straight and crisp every time the carrier is closed — which prevents the sweat band from shrinking. With two lockable latches, it can be flown as checked baggage or taken on board as a carry-on. It's so strong, it will withstand weight up to 300 pounds! All that and an inside mirror, too.



Campaign Hat Carrier with built-in hat press
Black, #512BK

Glendale sells black, navy and conservation green felt Campaign Hats on page 48.



Black #512BK **\$83.95** each*

*Add \$7 additional shipping if shipped to the lower continental US. Outside the continental US, higher surcharges apply. See page 81 for more information.

Sheriff's Hat Carrier Stetson style, #516BK



Sheriff's Hat Carriers (Stetson style)

This carrier is designed to fit up to a 4" hat brim with a "Crown Up" design — and it's strong enough to support over 200 pounds! Two lockable latches make this carrier ideal for airline travel — flown as checked baggage or as a carry-on. The hinges stop at 90°. Added benefits are the inside mirror and adjustable hat rest.



Black Sheriff's Hat Trap #516BK
\$64.95 each*

*Add \$7 additional shipping if shipped to the lower continental US. Outside the continental US, higher surcharges apply. See page 81 for more information.

Dress Cap Protective Cover

Protect your military dress cap with a lightweight and compact black nylon cover that is easy to transport and a cinch to store. Updated with an easy access ID plate. For military, police, and fire service personnel worldwide. Round male cover is 6.7 oz., 12" diameter. Oval female cover is 7.3 oz., 12 1/2" x 10 1/2". Black. Hand wash; air dry.

Dress Cap Protective Cover,

Male #517 **\$34.95** each
Female #518 **\$34.95** each



Dress Cap Protective Cover, #517

Service Cap Carrier #513



CoverBags for Service Caps, see page 69.

Service Cap Carrier

Protect and preserve any style and any size service cap. Inside this hard plastic carrier, an adjustable mount and a soft foam block will hold a cap in place when the case is closed. With two lockable latches, the case can be flown as checked baggage or taken on board as a carry-on. Black only. (Here's another customer product idea we were able to develop!)



Service Cap Carrier #513 **\$74.95** each*

*Add \$7 additional shipping if shipped to the lower continental US. Outside the continental US, higher surcharges apply. See page 81 for complete shipping information.



Firefighter's Ceremonial Pike Poles

Aluminium ceremonial pike with smooth, solid wood handle comes fully assembled. Chrome finish.
44½" overall. 1.8 lbs. #2262 **\$179.95** each



Firefighter's Ceremonial Pick Axes

Ceremonial pick ax, fully assembled. 12" x 5¼" Ax head with a smooth 36" solid wood handle.
Aluminium, 4 lbs. #2254 **\$229.95** each



Leather Universal Fire Radio Holster *NEW!*

Handcrafted in Maine from premium leather, these smartly designed holders are always ready to answer the call. Steel rivets and corrosion resistant D-rings. Adjustable anti-sway elastic straps. Belt loop for wearing without fire gear. Reflective strip on front. Carries radio up to 3.25" wide, 1.7" deep and 10" tall.
Radio Holster #9000-R **\$30.99** each



Glendale is your source for custom flags and banners!

Choose from affordable digital printing and traditional applique designs. Turn to page 92 for more information.



Fire Chief/Officer Cap #3063



Firefighter Cap #3062



Replacement Bell Crown Fire Cap Buttons

These are included with your caps, but if replacement buttons are needed, they can be ordered separately.

Gold #3069 **\$2.95** each
Silver #3070 **\$2.95** each

Bell Crown Firefighter Caps

Cushioned with a sweatband to assure non-slip comfort, each quality Fire Chief/Officer Cap has sides and top of white vinyl with a black plastic strap above the 2¼" long visor. The Firefighter cap sides and top are navy blue serge accented with a black plastic strap above the 2¼" long visor. Choose either gold or silver buttons (a gold or silver metal expansion strap or a gold or silver lace strap can be ordered separately). Available in small, medium, large, and extra-large (see chart below for sizing). Made-to-order allow 6-8 weeks for delivery.

Firechief/Officer Cap

Cap with gold buttons #3063 **\$89.95** each
Cap with silver buttons #3064 **\$89.95** each

Firefighter Cap

Cap with gold buttons #3061 **\$69.95** each
Cap with silver buttons #3062 **\$69.95** each

The Coverbag keeps your Bell Crown Firefighter Caps clean and safe see page 69.



Bell Crown Firefighter Cap Sizes and Equivalents

TO DETERMINE CAP SIZE: With a cloth measuring tape, measure completely around the head. Position the tape above the ears where you wish to wear the cap. Find your measurement below and the corresponding hat size.

Small	Medium	Large	XLarge
6½ - 20¾"	7 - 22¼"	7½ - 23¾"	7¾ - 24½"
6⅝ - 21⅝"	7⅛ - 22⅝"	7½ - 23¾"	7⅞ - 24⅞"
6¾ - 21½"	7¼ - 23"	7⅝ - 24⅞"	8 - 25¼"
6⅞ - 21⅞"			8½ - 25⅞"

Straps for Bell Crown Caps

Metal Expansion Straps, Gold #3030

Metal Expansion Straps, Silver #3031



Metal Expansion Straps

For that special touch, add a metal expansion strap in gold or silver finish. Use with Military-Style Uniform Caps, AF Service Caps, and Bell Crown Caps. Expands to 12" and fits any size cap.

Gold #3030 **\$19.95** each
Silver #3031 **\$19.95** each



Wire Lace Double Adjustable Straps, ½"

Gold #3067 **\$14.95** each
Silver #3032 **\$14.95** each

Fire Department and EMT Memorial Items see, page 53.





4" x 6" No Fray Ball Top Flags #0511



4" x 6" No Fray Spear Top Flags #0512

"No Fray" U.S. Flags

Made with a special fray-resistant fabric to better withstand the elements. Wood staffs which are preferred at gravesites.



- 4" x 6" with goldtone ball top #0511 **\$.69** each
- 4" x 6" with goldtone safety spear top #0512 **\$.39** each
- 8" x 12" with goldtone safety spear top #0515 **\$.89** each
- 12" x 18" with goldtone safety spear top #0516 **\$1.79** each



4" x 6" U.S. Spearhead Flags #0411

U.S. Spearhead Flags

Traditional hand-held flag often waved on parade routes. Poly/cotton flag in bright, permanent colors, securely stapled to black plastic staffs. Gilt spearheads.

- 4" x 6" with 10" black staff #0411 **\$.79** each
- 8" x 12" with 24" black staff #0412 **\$1.89** each
- 12" x 18" with 30" black staff #0413 **\$2.69** each



POW-MIA Flags, Patches and Pins are available at www.ParadeStore.com



Mourning Fan #7740

Pleated Mourning Fan

Purple and black nylon with canvas heading and brass grommets. 3' x 6'.



Mourning Fan #7740 **\$79.95** each

Mourning Pulldown

Purple and black nylon with canvas heading and brass grommets. Each is 20" wide.



- 8' #6701 **\$29.50** each
- 10' #6702 **\$32.95** each
- 12' #6703 **\$39.95** each



Honor Guard Breast Badges

These ceremonial wreath breast badges have a heft and level of detail that really make the grade. Plated with real gold or nickel to serve with distinction and never require polishing. Fastens with 3 clutch backs. 2" W x 1 1/4" H



- Gold #738 **\$89.75** each
- Nickel #739 **\$74.75** each

Honor Guard Horseshoe Heel Taps



These metal taps are sized for the shoe heel. Two in a set with extra nails. Please measure shoe heel, as there is no standardization in shoe size and heel size.

- 27/8" W x 31/8" H #3421S **\$10.95** set
- 27/8" W x 31/4" H #3421M **\$10.95** set
- 31/8" W x 33/8" H #3421L **\$10.95** set
- 31/4" W x 39/16" H #3421XL **\$10.95** set



Old Guard Cheater Bars #3423



Old Guard Cheater Bars

Worn on the inside of shoe heels to emphasize the "click" of the heels. Silver finish, 3 1/2" x 1". Two bars and four screws per set.

Old Guard Cheaters #3423 **\$13.50** set

CUSTOMER FAVORITE!



Civilian Guard Cheater Bars #3426

Civilian Guard Cheater Bars

These new and improved cheaters — in size, position of the screw holes, and the screws themselves — are designed to be more compatible with the men's and women's shoes worn by civilian honor guards. The black oxidized finish is rust resistant inside and out. 4" x 7/8". Two bars and four screws per set.

Civilian Guard Cheater Bars #3426 **\$13.50** set



Ceremonial Guard Hat/Lapel Pins

To be in an honor guard is a special privilege, one you can proudly declare with a hat and/or lapel pin. All pins are clutch back. **\$4.25** each



Honor Guard Hat Pin 1 1/8" W x 1/2" H #931



Color Guard Hat Pin 1 1/8" W x 1/2" H #932



Funeral Honor Guard Hat Pin, 1 1/2" W x 3/4" H #930



Flag Wreath Pin, Enameled finish 1 1/4" W x 1 1/4" H #976



Funeral Honor Guard Pin Enameled finish 1 1/8" W x 3/4" H #966

Honor Guard Pin Words only in red/white/blue 1 1/2" W x 5/8" H #941

Color Guard Pin Words only in red/white/blue 1 1/2" W x 5/8" H #940



Honor Guard Pin Goldtone finish 1" W x 1 1/2" H #975



Memorial Rifle Pin Goldtone finish 3/8" W x 1 1/2" H #982



CUSTOMER FAVORITE!

Armed Forces Flag Display Cases

These attractive cases are made of rich mahogany-colored hardwood and a thick glass for enduring service. A die-cast, gold-plated U.S. Armed Forces medallion is centered on the bevel-cut double mat. Felt lined with an easy-open back panel to insert the flag. Scratch-resistant bottom. Holds up to a 5' x 9½" cotton flag. Outside dimensions are 26"L x 13"H x 3½"D.

Army	#8025	\$84.95 each
Air Force	#8026	\$84.95 each
Navy	#8027	\$84.95 each
Marine Corps	#8028	\$84.95 each
Coast Guard	#8029	\$84.95 each



Casket Bands



Assure peace of mind during casket movement — when safety, protocol, and respect to our National Colors is of the highest concern — by securing the flag with this elastic band, which holds and blows a 5' x 9½" flag on a casket during ceremonies. Designed by a police officer with more than 22 years of experience as an honor guard member, team leader, and instructor. Available in black or white, 1" or 2" wide.

Black 1"	#27601	\$32.95 each
Black 2"	#27602	\$36.95 each
White 1"	#27611	\$32.95 each
White 2"	#27612	\$36.95 each

Turn to page 55 see our selection of American flags.

Memorial Flag Cases

Display and protect your treasured memorial flag in a beautiful wooden case with a glass front and removable back panel for easy insertion. Can be either free-standing or wall-mounted. (Flags not included.)

Capitol Case in Oak Finish #70130



Memorial Case in Cherry Finish #7011C



Veteran Case in Oak Finish #70140



Capitol Flag Case – for 3' x 5' flag.

Cherry Finish	#7013C	\$114.95 each
Oak Finish	#70130	\$114.95 each

Memorial Flag Case – for 5' x 9½' flag.

Cherry Finish	#7011C	\$96.95 each
---------------	--------	---------------------

Veteran Flag Case – for 5' x 9½' flag

Cherry Finish	#7014C	\$149.95 each
Oak Finish	#70140	\$149.95 each

Memorial Flag Hat/Lapel Pins/Patch

To be in an honor guard is a special privilege, one you can proudly declare with a hat and/or lapel pin or patch. All pins are clutch back.

Folded Flag Pin	#967	\$3.95 each
Folded Flag In Honor Pin	#980	\$3.95 each
Folded Flag In Memoriam Pin	#977	\$3.95 each
Patch	#1042	\$3.75 each



Folded Flag Pin, Enameled finish, 7/8" W x 1/2" H #967



Folded Flag – In Memoriam Pin 1" W x 3/4" H #977



Folded Flag – In Honor Pin 1" W x 3/4" H #980



Folded Flag — In Memoriam Patch Embroidered patch is 3"H x 4 1/4"W. #1042



Vinyl & Fabric Flag Bag #66

Vinyl & Fabric Flag Bag

Fabric back with zipper closure and clear vinyl front, 23" x 12". Holds up to a 5' x 9½" flag.

Vinyl Flag Bag	#66	\$12.95 each
----------------	-----	---------------------



Turn to page 55 to see our selection of flags.

Flag Protectors

Safeguard your cherished flag, shielding it from dust and dirt so that it can be passed down to the next generation.

Flag Box

Sturdy white storage carton protects any flag up to 5' x 9½". (Flag not included.) Ships FedEx Ground or Parcel Post only.

Flag Box	#50	\$7.95 each
----------	-----	--------------------



Flag Box #50



Firefighter, Police & EMT Mourning Cords



This shoulder cord started a new tradition for funeral honor guards. Designed by a member of a police honor guard and, like all Glendale shoulder cords, handcrafted in the U.S. The button loop-style (shown here) is worn with an epaulet that unbuttons. The open-end style with hook-and-eye closure is worn with epaulets that do not open. The wrapped pin attachment style can be worn on uniforms or shirts without epaulets or with epaulets that unbutton. The funeral honor guard stands at attention – a mourning band covers each member’s badge — and each uniform displays a unique mourning shoulder cord. It’s a look that is both distinctive and respectful. **These cords generally have a 28” circumference.** They can be custom-made in two longer lengths. Add \$5 to the price for an additional 5” and \$8 for an additional 10”. Then, add the length to the number -- for example, #4521106X5 or #4561107X10.

Fire, red line #4521107

EMS, green line #4521108



Police blue line #4521106

Badge Police Mourning Band Black with Blue Line, #1106

Police (Blue)

- Police, button loop. #4521106 **\$24.75** each
- Police, pin attachment #4521106P **\$24.75** each
- Police, open ends, hook and eye closure. #4561106 **\$27.95** each

Firefighter (Red)

- Firefighter, button loop. #4521107 **\$24.75** each
- Firefighter, pin attachment #4521107P **\$27.75** each
- Firefighter, open ends, hook and eye closure. #4561107 **\$27.95** each

EMS (Green)

- EMS, button loop. #4521108 **\$24.75** each
- EMS, pin attachment #4521108P **\$27.75** each
- EMS, open ends, hook and eye closure. #4561108 **\$27.95** each

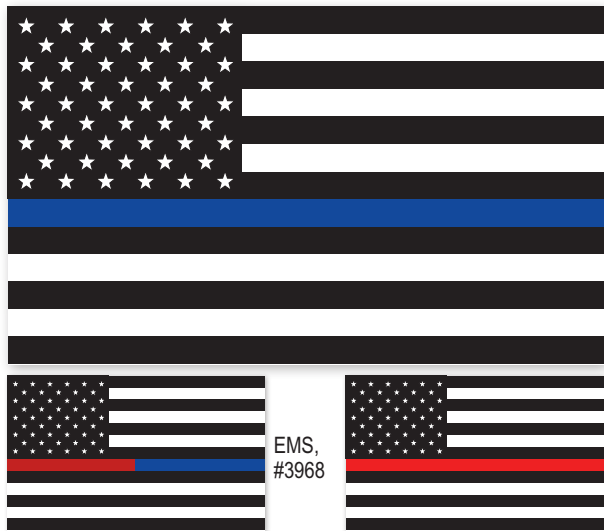

Police, #1107

EMS, #3968

Firefighter, #3969

Support Flags *NEW!*

Our Support Flags commemorate the fallen and their relationship with the community they serve. These flags are made from Nyl-Glo fabric with pole hem for parade use. 3' x 5'.

- Police #FLAG1106 **\$39.95** each
- Firefighter #4330 **\$39.95** each
- EMS #4329 **\$39.95** each

Memorial Flags

Sturdy nylon flags to display indoors or out to honor and remember. All are 3' x 5'. Outdoor flags have canvas heading and grommets; indoor flags have pole hem and no fringe.

- Firefighter Mourning Flag (outdoor display). #7780 **\$59.95** each
- Firefighter Remembrance Flag (outdoor display) #7725 **\$63.50** each
- Firefighter Remembrance Flag (indoor display) #7758 **\$73.50** each
- Police Mourning Flag (outdoor display). #7781 **\$59.95** each
- Police Remembrance (outdoor display).. #7726 **\$62.25** each
- Police Remembrance Flag (indoor display). #7759 **\$69.95** each
- EMS Mourning Flag (outdoor display). #7851 **\$99.75** each



Firefighter, #1107



Black, #1105



EMS, #1108



Nemo Me Impune Lacessit, #1110

Police/Firefighter/EMS Badge Mourning Bands

Elastic bands to cover a badge, shield, or star as a sign of respect and honor when a fellow police officer, firefighter, or EMT dies in the line of duty. Each is 3/4" wide and stretches to 3".

General Mourning

Black #1105 **\$2.75** each

Police

Black with Blue Line #1106 **\$2.75** each

Nemo Me Impune Lacessit

Black with purple lines and gold letters #1110 **\$4.25** each

Firefighter

Black with Red Line #1107 **\$2.75** each

EMS

Black with Green Line #1108 **\$2.75** each

Firefighter Remembrance, #7725 / 7758

EMS Mourning, #7851



Police Mourning, #7781



Spartanburg County, SC Sheriff's Office at the 2017 Police Week National Honor Guard Competition

Honor Guard Check List

Excerpted from "The Honor Guard Manual" (See page 14)

Basic Equipment Needs

1. Three 8' flagstaves
2. Three 3' x 5' flags (US, State, Organization)
3. Three flag stands
4. Three flag carriers
5. Two ceremonial rifles (two ceremonial pike poles and/or fire axes)

Uniform Item Suggestions

1. Two sets of gloves for each member
2. Special ceremonial uniform
3. Ceremonial belt
4. Honor Guard badge
5. Aiguillette
6. Shoes with additional soles and/or taps

Additional Equipment to Consider

1. Three 9' 6" flagstaves
2. Three 4' x 6' flags
3. Practice flags (saves wear and tear on the ceremonial flags)
4. Ten swords or sabers
5. Ten ceremonial rifles (minimum, for cordons)
6. All joint service 3' x 5' flags and 8' flagstaves (5 each)
7. POW/MIA 3' x 5' flag, and 8' flagstaff
8. Each service's general/admiral flags (3' x 5' only)
9. Ten flag stands

Honor Guard Ready



DrillAmerica 1903 Springfield Rifle®
Black with Black Metal
#DA1903BK

DrillAmerica® 1903 Springfield Replica Rifle

Wood Grain Rifle Stock

- DrillAmerica® 1903 Springfield Replica Rifle black metal
#DA1903 **\$279.95** each
- DrillAmerica® 1903 Springfield Replica Rifle chrome metal
#DA1903C **\$324.95** each

Black Rifle Stock

- DrillAmerica® 1903 Springfield Replica Rifle black metal
#DA1903BK **\$274.95** each
- DrillAmerica® 1903 Springfield Replica Rifle chrome metal
#DA1903BKC **\$319.95** each

White Rifle Stock

- DrillAmerica® 1903 Springfield Replica Rifle chrome metal
#DA1903WHC **\$324.95** each



SURE-GRIP
Honor Guard
Gloves

Long
10½" - 11"

Honor Guard Gloves

Best quality cotton with a touch of Lycra® stretch for extra comfort. **Long** 10½ - 11"(to cover the wrist:) S-M or L-XL

Sure-Grip

White #1078 **\$8.95** pair

Honor Guard Metal Arc Pins

All pins are a shiny gold metal with bright, colorful enamel and double clutch back. Shown actual size: 1½" x ¾". **\$5.95** each



Honor Guard — cream
#850



Honor Guard — orange
#873



Honor Guard Pin

Goldtone finish, clutch back. 1" W x 1½" H

#975 **\$4.25** each

Honor Guard Hat/Collar/Lapel Pins

All pins are double clutch back and shown actual size: 1¾" x ¾". **\$3.75** each



Honor Guard #785B Brass



Honor Guard #785N Nickel

Honor Guard Pin

Words only in red/white/blue 1½" W x 5/8"H
#941 **\$4.25** each



USAF Honor Guard Pin

Honor Guard Hap Arnold
#709 **\$11.95** each

USAF Ceremonial belts are on page 67.

Army Ceremonial belts are on page 35.

Shoes and Taps are on page 39.

POW/MIA Flags and accessories are online only.



Perfect-Fit Aluminum Poles

Two-Piece and Telescoping Styles

Precision-engineered to be incredibly lightweight and easy to handle, these beautiful poles are the choice of America's leading color guards and marching bands. Made from strong aluminum tubing with a rich gold anodized or bright silver mill finish, each two-piece pole has a base plug, a ring for attaching cord with tassels, and two adjustable rings to hold a flag tautly in place. The Telescoping Pole has an internal sleeve joint that forms a secure lock.

Gold	8'x1 1/8"	1.9 lb	88GE	\$103.95	each
Gold	9'x1 1/8"	2.1 lb	98GE	\$105.95	each
Silver	8'x1 1/8"	1.9 lb	88SE	\$103.95	each
Silver	9'x1 1/8"	2.1 lb	98SE	\$105.95	each
Telescoping Pole:					
Gold only	6' to 10'x 1 1/8"	1.4 lbs	98TGE	\$79.95	each



7' x 1" Gold Parade Pole #71GE

Telescoping Gold Parade Pole #98TGE



Black Clarino with nickel, #897BKC



Honor Guard Leather Flag Carriers

The standard of quality. This double harness is made from skillfully stitched top quality leather with premium polished metal flag cups to serve proudly for years to come. Double adjustable 1 3/4" straps. Hole at bottom of cup accommodates guidon pole.

Black with brass	#896BK	\$247.95	each
Extra Large Black with brass	#896BKXL	\$257.95	each
Black with nickel	#897BK	\$239.95	each
Extra Large Black with nickel	#897BKXL	\$254.95	each
Black Clarino with brass	#896BKC	\$259.95	each
Black Clarino with nickel	#897BKC	\$249.95	each
White with brass	#896WH	\$281.95	each
White with nickel	#897WH	\$269.95	each

Honor Guard Cap Straps

Honor Guard Cap Back Strap, black gloss patent leather #3034 **\$9.50** each



USAF Honor Guard Cap Straps

Wear leather cap straps down as chinstraps to keep in place during ceremonies, continuous drill movements, or in adverse conditions.

Honor Guard Cap Strap, silver #3032 **\$14.95** each



U.S. Flags: Indoor & Parade Use, Nylon

3' x 5' fringed	#0215	\$88.75	each
3' x 5' unfringed	#0211	\$75.25	each
4' x 6' fringed	#0216	\$133.95	each
4' x 6' unfringed	#0212	\$119.95	each

More US flags see pages 98-99

U.S. State Flags

3'x5' Flags start at \$36.95 See page 95 for pricing

Custom Flags

3'x5' Custom Flags See page 92 for options and pricing



Perfect-Fit Poles

Are threaded to precisely fit our Perfect-Fit Ornaments (see page 88).



Unfringed US Flag

Liberty Stand Chrome #L8

Liberty® Floor Stands

Made of strong ABS plastic with a bright metalized finish. Includes an adapter sleeve to allow use with a pole of 1-1/4" diameter. The base of each stand measures 11 1/2". (The 2-lb. stand is not weighted; the 8-lb. stands are weighted with sand; 15- and 20-lb. stands, with sand and Dura-steel shot.)

Chrome 2 lbs.	#LE	\$57.95	each
Chrome 8 lbs.	#L8	\$59.95	each (\$7*)
Gold 2 lbs.	#LGE	\$57.95	each
Gold 8 lbs.	#LG8	\$59.95	each (\$7*)

* There is a shipping surcharge for weighted floor stands over 2 lbs.. The surcharge is in parentheses following the price.



Our Best Seller!

Liberty Stand Gold #LG8

Competition Color Guard Checklist

For the color guard unit looking to be highly proficient in competitions, Glendale Parade Store enlisted the help of professional drill team trainers to determine the best gear for competition color guards!

After more than a decade of National Championship-winning excellence, this gear comes recommended by the top color guard instructor in the country, Edford Luckey, MSG, USA (Ret.) formerly of Alamo Heights High School in San Antonio, TX.

NOTE: This gear checklist does NOT apply to MCJROTC units who must drill in strict accordance with their service guidance.

Start with Poles and Toppers

Traditional Fit Two-Piece Aluminum Poles: see page 91

For male/mixed teams, select 8'x1 1/4".

#84S (Silver) or #84G (Gold)

For all-female teams, select 8'x1".

#81S (Silver) or #81G (Gold)

Aluminum poles add snap and pop to all your standing manual, ensuring your unit catches the judge's eye!

Round Spears are the BEST choice for uncasing/casing of the colors in competition due to their rounded edges!

Styrene Traditional Fit Round Spears see page 89

#85SC (Silver) or #85SG (Gold)

Traditional Fit 7" Army Spades see page 89

#22C (Chrome) or #22B (Brass)

Suitable for both National and Organizational/State colors!

You'll want the best carriers...

Leather Flag Carrier, Double-Harness with Plastic Cup

#1802BK (Black) or #1802WH (White) see page 84

The larger diameter and material of the cup ensures no misses and amazing audio to "WOW" the judges! Also available in Clarino high-gloss finishes!

Don't forget casings to protect the colors...

Canvas Flag Covers

#68 (Choose Your Color/Imprinting) see page 85

Choose from our wide variety of colors and imprint with lettering of your choice for a sharp look! These can be pressed and starched for crisp performance!

Each member will need a belt...

Military Police Belt #180 (Choose Your Color/Finish) see page 34

Easy to maintain and classy, these belts will compliment each of your color guard cadets! Make sure to get one for each member of your color guard!

Last but not least...

3x4 Un-Fringed American flag #0223 see page 99 and State Colors call for custom quote on state flags!

The 3x4 size ensures that flags do not hang in cadets' faces helping vision/alignment and displaying their amazing bearing to the judges! The shorter length means fewer cranks while uncasing/casing the colors! We recommend NO fringe for competition units, especially those uncasing/casing the colors!

Do you need rifles?

Check out our selection of competition-ready drill rifles on pages 4-14! While any of these rifles are suitable for competition, we recommend the DrillAmerica 1903 Springfield replica rifle for its sharp appearance and exceptional balance!

Army JROTC and ROTC Ribbons



Ribbon mounts are on page 71.

Superior Cadet Award Set

Set includes boxed medal, ribbon and pin.

JROTC

Set #9026 **\$29.95** each

Ribbon Only
#R9026 **\$1.95** each

ROTC

Set #9027 **\$29.95** each

Ribbon Only
#R9027 **\$1.95** each

Superior Cadet
Award Set
#9026



JROTC and ROTC Ribbons

Regulation JROTC and ROTC Ribbon Slides. Order by ribbon number.

N Series - Army JROTC #N **\$1.35** each

R Series - Army ROTC #R **\$1.35** each

JROTC and ROTC Ribbon Drapes

Regulation JROTC and ROTC Ribbon Drape with pin and safety catch and gold ring.

ND Series - Army JROTC #NDG **\$3.50** each

RD Series - Army ROTC #RDG **\$5.75** each

For a complete listing of all our ribbons, with photos, visit us online at www.ParadeStore.com



Ribbon Drapes
Army JROTC Ribbon
Drapes that match award
medals are shown on page
75.

#NDG11
Distinguished Cadet



Torch Award

Lamp of Knowledge Award

Ribbon Attachments

Torch measures: 1/4" high. Lamp measures: 1/4" wide.

Torch Awards, Senior—bronze, silver, gold (2nd, 3rd, 4th).

Torch Award #2085 **\$1.95** each

Lamp of Knowledge Awards, Junior—bronze, silver, gold.

Lamp of Knowledge Award #2086 **\$1.70** each

Army ROTC Pins and Patches



Academic Achievement



Honor Unit

Meritorious Unit



Honor Unit with Distinction

ROTC Honor Insignia

Academic Achievement, gold. #775 **\$6.75** each

Honor Unit, blue enamel star. #776 **\$3.75** each

Honor Unit w/ Distinction, gold enamel star. #777 **\$4.95** each

Meritorious Unit, white enamel star. #779 **\$4.75** each

Felt Pads for Achievement insignia sold above:
red, gray, gold. #778 **\$1.30** each



Army ROTC Distinguished Cadet Badge

Silver finish, clutch back. #903 **\$12.50** each



ROTC Rifle Badges

Each 2 3/8" with nickel finish.

Rifle, plain #9020 **\$8.95** each

Rifle, 1 star #9021 **\$10.50** each

Rifle, 2 star #9022 **\$10.50** each



Physical Fitness Excellence Patch

Patch, full color, 2 1/2".

Full color #832

\$4.95 each

 This symbol indicates
Made in America

Raider and Ranger



#8290CP



Gold on Black

Raider Tabs

- Gold on black #829C11 \$2.50 each
- OCP with Velcro™ #8290CP \$4.25 each



Gold on Black

Raider Challenge Tabs

- Army JROTC Competition
- Gold on black #836C11 \$2.50 each
- OCP with Velcro™ #8360CP \$4.50 each



Gold on Royal Blue

Ranger Tabs

- Gold on royal blue #828C10 \$2.50 each
- Gold on black #828C11 \$2.50 each
- White on black #828C17 \$2.50 each
- OCP with Velcro™ #8280CP \$4.50 each



Gold on Black

Ranger Challenge Tabs

- Army SR ROTC Competition
- Gold on black #830C11 \$2.50 each
- OCP with Velcro™ #8300CP \$3.25 each



Regulation

Dress Mini

Ranger Pins

- Regulation: gold plated, clutch back, 1 1/4" #828PR \$6.25 each
- Dress Mini: gold plated, clutch back, 3/4" #828PM \$5.75 each



Army ROTC Ranger Beret Flash

- Gold and black #831 \$3.50 each

Ranger Beret Flash

See page 42 for more Beret Flashes.



JROTC Challenge Coin

Army JROTC Front



Design on back



glendale
exclusives

Actual Size

JROTC Challenge Coin

By popular request, here's another Glendale exclusive! These JROTC Challenge Coins are available for all units. All have the eagle and sunburst on the reverse side in matching finish. Each coin is 1 1/2" in diameter.



Army JROTC Challenge Coin, antique gold finish #CCAJR \$11.50 each

Shoulder Tabs and Patches

Army Cadet Command Patches



- Full color #842 \$4.75 each
- Hook backing for OCP #8420CP \$6.95 each

Army JROTC Patches



- Full color #840 \$5.25 each
- Hook backing for OCP #8400CP \$7.95 each

Shoulder Tabs



Standard Shoulder Tabs are 2 3/4" across; OCP Digital Shoulder Tabs are 3 3/4" across. Hook backing. Not shown to size.

OC Digital Camo

- Honor Guard #8210CP \$3.50 each
- Drill Team #8230CP \$3.50 each
- Rifle Team #8240CP \$3.50 each
- Color Guard #8250CP \$3.50 each

ACU Digital Camo

- Honor Guard #821ABU \$4.25 each
- Drill Team #823ABU \$4.25 each
- Rifle Team #824ABU \$4.25 each
- Color Guard #825ABU \$4.25 each

Colored Tabs See Color Chart below

- Honor Guard #821 \$2.50 each
- Drill Team #823 \$2.50 each
- Rifle Team #824 \$2.50 each
- Color Guard #825 \$2.50 each

How to order Shoulder Tabs

To order shoulder tabs, indicate # of shoulder tab + # of color - for example, the Honor Guard tab in white on royal, should be ordered as #821C16.

Lettering	Background	Border
C10	Gold	Royal Blue
C11	Gold	Black
C13	Gold	Red
C15	White	Red
C16	White	Royal Blue
C17	White	Black
C19	White	Brown
C20	White	Kelly Green
C23	Royal Blue	White
C24	White	Maroon
C26	Red	White
C27	Royal Blue	White
CS	Black	OD



#8420CP



Full color



Full color



#8400CP



#8210CP



#821
C23



#8230CP



#823
C15



#8240CP



#824
C10



#825ABU



#825
C27

Qualification Badges

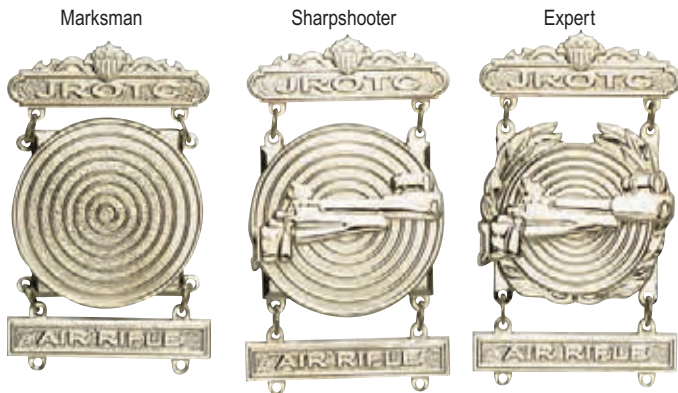

All Three Different Badges available in either Bright Nickel (shown above) or Silver Oxide (shown below)



Army JROTC Qualification Badges

Choose from six badge styles, all available in Bright Nickel or Silver Oxide finish. 2 1/2" H x 1 1/2" W.

	Silver Oxide	Bright Nickel
Marksman, Air Rifle	#3010 \$12.95	#3110 \$12.95
Sharpshooter, Air Rifle	#3012 \$13.95	#3112 \$13.95
Expert, Air Rifle	#3014 \$14.75	#3114 \$14.75

Cap Devices



Cadet Officer Cap Device

- Army Service Cap Device
- Male, screw back #9002 **\$12.95** each
- Female, clutch back #9003 **\$11.95** each



Regulation ROTC Cap Device

- with letters in panel: gold plate, screw back or clutch back.
- Screw back #9001SB **\$7.95** each
- Clutch back #9001CB **\$5.95** each

= PERMANENT SHINE. No polish! Gently wipe with clean, soft cloth.

Flags



Cadet Double Guidon Available with up to 2 letters or numbers



Raider Platoon

Cadet Command Double Guidon

This flag with Leadership Excellence emblem is made to customer specifications with a pole hem — 20" x 27 3/4" Allow 3–5 weeks for delivery.



Emblem only	#7703	\$99.95 each
Emblem and 1 number/letter	#7703C1	\$109.95 each
Emblem and 2 numbers/letters	#7703C2	\$119.95 each

Raider Platoon Flag

Black with gold letters, single reverse, and pole hem, 20" x 27 3/4".

Raider Platoon Flag	#2225	\$119.95 each
---------------------	-------	----------------------



Customizable JROTC Unit Flag

Double Lined construction. Pole hem with Velcro Tabs

For Outdoor Use

Appliqued/Embroidered Design on nylon #AJROTCFLAG 3' x 4' **\$899.00**

For more custom flags turn to page 92



Custom Guidon

Let Glendale help you design your unit's custom guidon. See page 92 for options and pricing. Contact customwork@glendale.com to have a guidon made for your unit.



Insignia

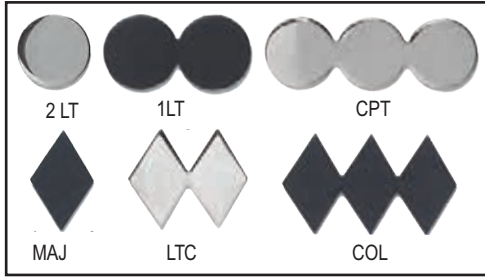

ROTC Rank Insignia

Smooth metal, all have military clutch backs.

2nd Lt: Single disc		
Silver-plated	#2801	\$6.50 pair
Black metal (Subdued)	#2807	\$6.25 pair
1st Lt: Double disc		
Silver-plated	#2811	\$7.95 pair
Black metal (Subdued)	#2815	\$6.95 pair
Capt: Triple disc		
Silver-plated	#2819	\$9.95 pair
Black metal (Subdued)	#2823	\$8.50 pair
Maj: Single diamond		
Silver-plated	#2802	\$6.95 pair
Black metal (Subdued)	#2808	\$5.95 pair
Lt Col: Double diamond		
Silver-plated	#2812	\$7.95 pair
Black metal (Subdued)	#2816	\$6.95 pair
Col: Triple diamond		
Silver-plated	#2820	\$9.95 pair
Black metal (Subdued)	#2824	\$8.50 pair

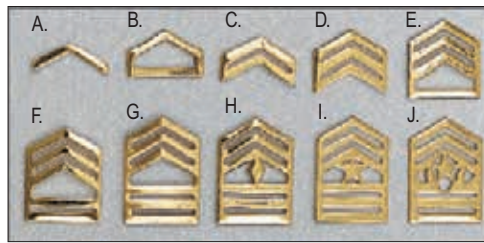

Army ROTC Metal Chevrons

Senior division choose	Plated, pair	Black, pair
Gold-plated or Black (Subdued).	#9010	#9011
A- Private	\$4.95	\$4.75
B- Private First Class	\$5.95	\$4.95
C- Corporal	\$7.25	\$5.25
D- Sergeant	\$7.50	\$5.50
E- Staff Sergeant	\$7.75	\$5.75
F- Sergeant First Class	\$7.95	\$5.95
G- Master Sergeant	\$8.25	\$6.25
H- First Sergeant	\$8.50	\$6.50
I- Sergeant Major	\$8.75	\$6.75
J- Command Sergeant Major	\$8.95	\$6.95



ROTC Collar Insignia

Gold plate, clutch back.	#910	\$6.25 pair	
Nickel plate, clutch back.	#911	\$5.75 pair	
Subdued, clutch back.	#912	\$5.25 pair	

JROTC Collar Insignia

Gold plate, clutch back.	#914	\$6.25 pair	
Nickel plate, clutch back.	#915	\$5.95 pair	
Subdued, clutch back.	#916	\$5.50 pair	



Torch on Disc

Brass, clutch back.	#913	\$9.25 pair	
---------------------	------	-------------	--

Torch on Disc

Large chevrons-male

Small chevrons-female

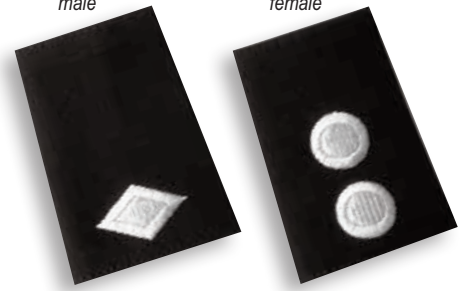

Command Crest

Army Cadet	
Command Crest	
#842C	\$8.75 each

Scorpion OCP Cadet Rank

Hook backing, specify rank.

Scorpion OCP	#9050	All \$4.50 each
--------------	-------	-----------------

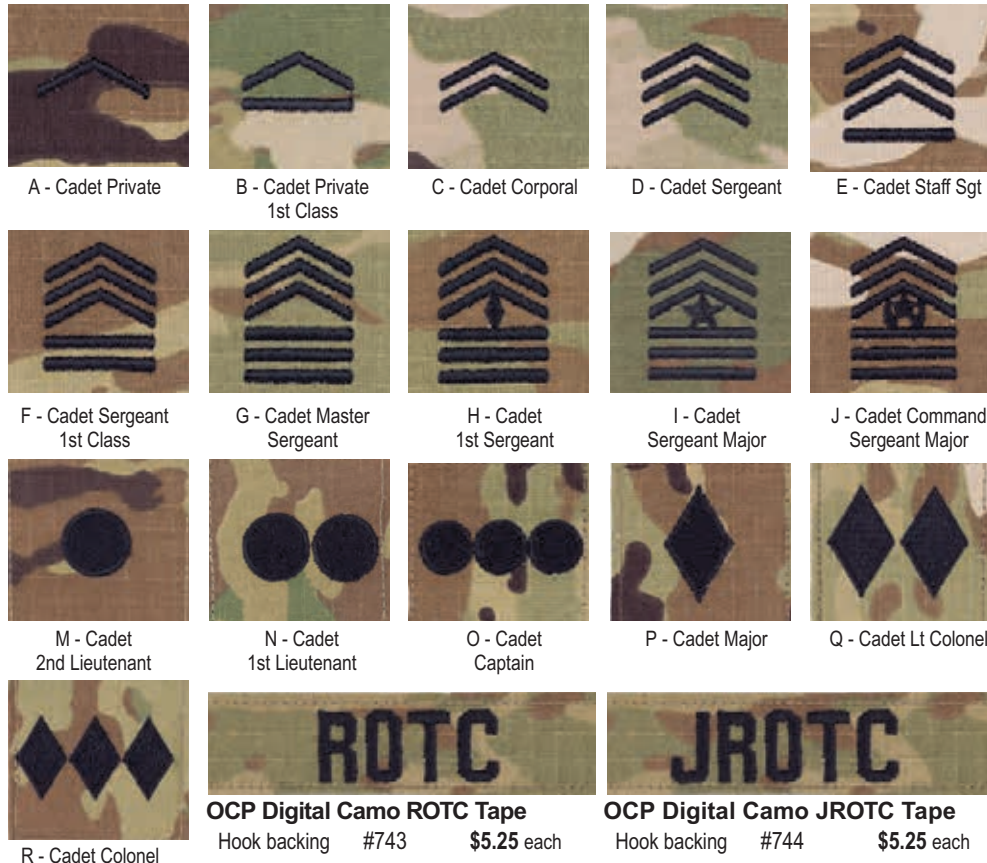

Army ROTC Cadet Epaulets

#9013	Large chevrons: male, pair.	
#9014	Small chevrons: female, pair.	
A - Private		\$7.95
B - Private First Class		\$8.75
C - Corporal		\$8.75
D - Sergeant		\$9.25
E - Staff Sergeant		\$9.95
F - Sergeant First Class		\$10.25
G - Master Sergeant		\$10.95
H - First Sergeant		\$11.95
I - Sergeant Major		\$12.50
J - Command Sergeant Major		\$12.50
M - Second Lieutenant		\$8.75
N - First Lieutenant		\$10.25
O - Captain		\$11.95
P - Major		\$9.25
Q - Lieutenant Colonel		\$10.95
R - Colonel		\$12.50



Scorpion OCP Custom Camo Tape

Letters are black on digital camo background with hook backing. 15 letters max. Submit names in writing. Please allow 10 business days for customizing.

#ACUTAPE Custom	\$5.50 each
#OCPTAPE-ARMY Custom	\$4.95 each

= PERMANENT SHINE. No polish! Gently wipe with clean, soft cloth.

Insignia

AFJROTC Cadet Officer Insignia



AFJROTC Cadet Officer Insignia

Silver and enamel with clutch back fastener, 5/8" W x 1 1/8" H. Specify Rank

- #9011 **\$14.95** pair
 - M- 2nd Lieutenant
 - N- 1st Lieutenant
 - O- Captain
 - P- Major
 - Q- Lieutenant Colonel
 - R- Colonel
- (For Senior Program:
#9011M = 4th Class;
#9011N = 3rd Class)

AFROTC Cadet Officer Insignia

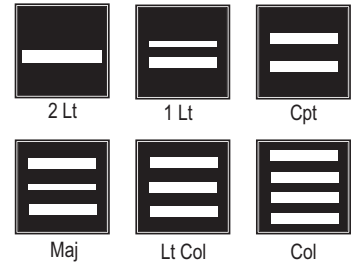

AFROTC Cadet Officer Insignia

Cadet Officer Insignia, black and silver, clutch back, Specify Rank #9015 **\$11.50** pair

- M- 2nd Lieutenant
- N- 1st Lieutenant
- O- Captain
- P- Major
- Q- Lieutenant Colonel
- R- Colonel

Cadet Airman Insignia



Cadet Airman Insignia

Silver and enamel chevrons with clutch back fastener. (These all match current regulations.) Specify Rank #9009

- A- Airman **\$14.25** pair
- B- Airman 1st Class **\$15.25** pair
- C- Senior Airman **\$16.25** pair
- D- Staff Sergeant **\$16.50** pair
- E- Tech Sergeant **\$16.75** pair
- F- Master Sergeant **\$19.95** pair
- G- Senior Master Sergeant **\$20.95** pair
- I- Chief Master Sergeant **\$21.95** pair

Cap Devices



Cadet Officer Cap Devices

- AFROTC POC Service Cap Device: screw back. #9004 **\$13.95** each
- AFROTC POC Flight Cap Device: clutch back. #9005 **\$10.95** each
- AFJROTC Cadet Officer Service Cap Device: screw back. #9006 **\$19.95** each
- AFJROTC Cadet Officer Service Cap Device: clutch back. #9007 **\$19.95** each

AFROTC GMC & JROTC Cadet Airman Cap Devices

- AFROTC Service Cap Device: screw back. #901 **\$26.95** each
- AFROTC Flight Cap Device: clutch back. #902 **\$9.95** each
- AFROTC Service Cap Device: clutch back. #908 **\$24.95** each

Flags



Air Force JROTC Flags

All AFJROTC flags are Indoor/Parade only. They have a royal blue background with the shield emblem in the center.

- Single with fringe, 3' x 5' #7700AF5 **\$99.95** each
- Single without fringe, 3' x 5' #7700AF6 **\$74.95** each
- Double with fringe, 3' x 5' #7700AF7 **\$139.95** each

"You went above and beyond to make sure that we were taken care of and received our items in plenty of time. Thank you so much!!!"

Ron King, IN



AFROTC and AFJROTC Soft Epaulets

Specify size: male (LG) female (SM)

- | | |
|------------------------------|------------------------------|
| AFJROTC, POC grade. #9017 | AFROTC, POC grade. #9018 |
| M- 2Lt \$11.50 pair | M- 2Lt \$13.25 pair |
| N- 1Lt \$12.50 pair | N- 1Lt \$13.75 pair |
| O- Capt \$13.25 pair | O- Capt \$14.25 pair |
| P- Maj \$14.75 pair | P- Maj \$14.75 pair |
| Q- LtCol \$15.25 pair | Q- LtCol \$15.50 pair |
| R- Col \$16.50 pair | R- Col \$16.50 pair |

Badges



AFJROTC Badges

- Ground School #905 **\$10.95** each
- Flight Solo #906 **\$10.95** each
- Flight Certificate #907 **\$10.95** each

AFROTC Badges

- Navigator #9030 **\$10.95** each
- Flight Pilot #9031 **\$10.95** each
- Senior Navigator Instructor Wings #9032 **\$14.75** each

P = PERMANENT SHINE. No polish! Gently wipe with clean, soft cloth.

Awards



Missile Badge
Bright Nickel #9024 **\$12.95** each

Model Rocketry Badge
Bright Nickel #9023 **\$10.95** each



AF Wings and Prop Collar Devices

Solid Bright Nickel
#909 **\$13.95** pair
Nickel propeller/ gold-plated wings.
#917 **\$15.95** pair



AFJROTC & AFROTC Ribbon Awards

Slide only. Please order by name.

AFROTC	#2081	\$1.35 each
AFJROTC	#2080	\$1.35 each

A complete listing with photos of all our ribbons can be seen on our website at www.ParadeStore.com.



AFROTC Cadet Training Officer Badge & AFJROTC Distinguished Cadet Badge

Blue enamel, clutch back #904 **\$11.50** each



Hap Arnold Beret Device

Solid Bright Nickel #709S **\$9.95** each



AFJROTC #741ABU

Shoulder Patches

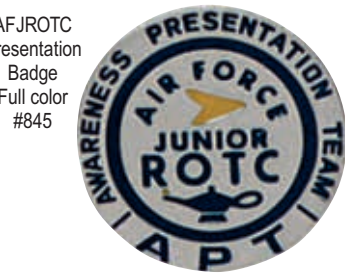

Cadet Airman Patches & Badge

AFJROTC Awareness Presentation Team Badge Full color 1 1/2". #845 **\$5.95** each

AFJROTC Patch:

Full color	#844	\$4.25 each
Full color Velcro	#844V	\$5.50 each
OCP	#844OCP	\$6.50 each



AFJROTC Patch Full color #844

Visit paradestore.com to see the complete selection of Air Force OCP insignia and patches.



AFJROTC #741OCP

ABU Digital Camo and OCP AFJROTC Tape

Letters are dark blue on digital camo background.

#741	AFJROTC ABU Tape, Sew-on	\$4.95 each
#747	AFJROTC ABU Tape, Hook backing	\$5.25 each
#741OCP	AFJROTC OCP Tape, Sew-on	\$4.95 each
#747OCP	AFJROTC OCP Tape, Hook backing	\$5.95 each



Custom Tape #ABUTAPE

JROTC Challenge Coin



Air Force JROTC Front



Design on back

JROTC Challenge Coin

By popular request, here's another Glendale exclusive! These JROTC Challenge Coins are available for all units. All have the eagle and sunburst on the reverse side in matching finish. Each coin is 1 1/2" in diameter.

Air Force JROTC Challenge Coin, antique nickel finish #CCAFJR **\$11.50** each



Custom Tape #OCPTAPE

ABU Custom Digital and OCP Camo Tape

Letters are dark blue on digital camo background with hook backing. 15 letters max. Submit names in writing. Please allow 10 business days for customizing.

#ABUTAPE Custom	\$4.95 each
#OCPTAPE-AIR FORCE Custom	\$4.75 each

Call for OCP Shoulder Patches and Insignia
1-800-653-5515

Awards

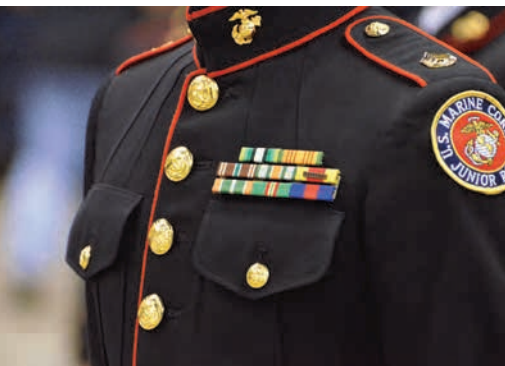

Navy JROTC Award Ribbons

Slide only. Please order by name.

Award Ribbons #2082 \$1.35 each

Marine Corps JROTC Award Ribbons

Slide only. Please order by name.

Award Ribbons #2083 \$1.35 each

 There's an extensive list of ribbon mounts and ribbon attachments on page 71.

A complete listing with pictures of all our ribbons can be seen on our web site at www.paradestore.com.



2019 National High School Drill Championships.

Insignia

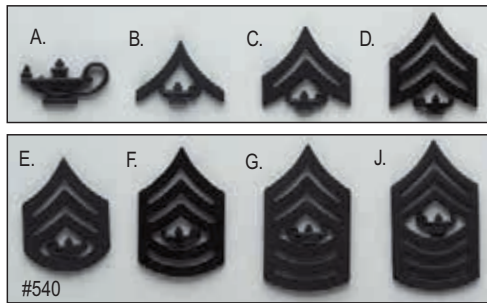

MCJROTC Metal Chevrons

All have military clutch backs. Indicate rank

	Black, #540	Gold, #541
A- Private First Class	\$5.95 pair	\$8.50 pair
B- Lance Corporal	\$7.50 pair	\$8.50 pair
C- Corporal	\$7.75 pair	\$9.25 pair
D- Sergeant	\$7.95 pair	\$9.75 pair
E- Staff Sergeant	\$7.95 pair	\$9.75 pair
F- Gunnery Sergeant	\$8.25 pair	\$10.25 pair
G-1st Sergeant	\$9.25 pair	\$10.50 pair
J-Sergeant Major	\$9.95 pair	\$10.95 pair

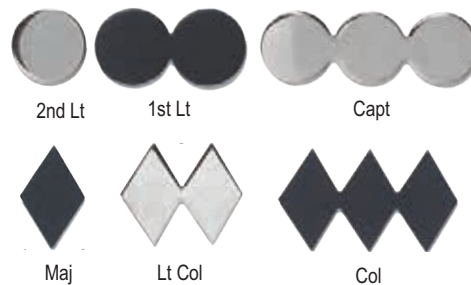

ROTC Rank Insignia

Smooth metal, all have military clutch backs.

2nd Lt: Single disc		
Silver-plated	#2801	\$6.50 pair
Black metal (Subdued)	#2807	\$6.25 pair
1st Lt: Double disc		
Silver-plated	#2811	\$7.95 pair
Black metal (Subdued)	#2815	\$6.95 pair
Capt: Triple disc		
Silver-plated	#2819	\$9.95 pair
Black metal (Subdued)	#2823	\$8.50 pair
Maj: Single diamond		
Silver-plated	#2802	\$6.95 pair
Black metal (Subdued)	#2808	\$5.95 pair
Lt Col: Double diamond		
Silver-plated	#2812	\$7.95 pair
Black metal (Subdued)	#2816	\$6.95 pair
Col: Triple diamond		
Silver-plated	#2820	\$9.95 pair
Black metal (Subdued)	#2824	\$8.50 pair

Cap Devices



Navy JROTC Cap Devices

Small Fouled Anchor for Garrison Cap, clutch back	#642	\$6.95 each
Large Fouled Anchor for Combination Cap, screw back	#643	\$11.95 each

ROTC Mini Rank Insignia

Smooth metal all have military clutch backs.

2nd Lt: Single disc		
Silver-plated	#2831	\$8.50 pair
1st Lt: Double disc		
Silver-plated	#2833	\$8.50 pair
Capt: Triple disc		
Silver-plated	#2835	\$8.50 pair
Maj: Single diamond		
Silver-plated	#2832	\$8.50 pair
Lt Col: Double diamond		
Silver-plated	#2834	\$8.50 pair
Col: Triple diamond		
Silver-plated	#2836	\$8.50 pair

JROTC Challenge Coins



Navy JROTC Front



Marines JROTC Front



Design on back of both

JROTC Challenge Coins

By popular request, here's another Glendale exclusive! These JROTC Challenge Coins are available for all units. All have the eagle and sunburst on the reverse side in matching finish. Each coin is 1 1/2" in diameter.

Navy JROTC Challenge Coin, Antique gold finish	#CCNJR	\$11.50 each
Marine Corps JROTC Challenge Coin, Antique gold finish	#CCMJR	\$11.50 each

glendale  exclusives 



USMC Cotton Web
Khaki Belt #8168

USMC Dress Buckle only,
gilt emblem #8164

USMC Belts & Buckles

USMC Dress Buckle only, no emblem, 2" x 3".
#8163 \$41.95 each
USMC Dress Buckle only, gilt emblem, 2" x 3".
#8164 \$41.95 each
USMC cotton web khaki belt — 1 1/4" wide, 44" long
with open, solid brass, gold-plated and
hand-polished buckle. Government spec.
#8168 \$17.50 each

= **PERMANENT SHINE**. No polish!
Gently wipe with clean, soft cloth.

Marine Corps Flag
#7714
see page 96 for
sizes and prices.

**Turn to page
96 for Marine
and Armed
Forces flags.**

USMC Collar Insignia



USMC Enlisted
Collar Device
#722

USMC Officer Service Collar Device

Black, screw back. #721 **\$19.95** pair

USMC Enlisted Collar Device

Gold plate, screw back. #722 **\$11.50** pair

USMC Enlisted Collar Device

Black, screw back. #723 **\$9.95** pair

= **PERMANENT SHINE**. No polish!
Gently wipe with
clean, soft cloth.

Band Insignia



Lyre in
Wreath
#658G



Lyre Collar
Insignia
#659G

USMC Cap Insignia



USMC Officer
Dress Cap Device
#715



USMC Enlisted
Dress Cap Device
#717

USMC Officer Dress Cap Device

Gold/silver, screw back. #715 **\$41.50** each

USMC Officer Service Cap Device

Black, screw back. #716 **\$14.75** each

USMC Enlisted Dress Cap Device

Gold plate, screw back. #717 **\$8.75** each

USMC Enlisted Service Cap Device

Black, screw back. #718 **\$6.75** each

Band Cap Devices

Lyre in wreath: gold plate, screw back.

#658G **\$8.75** each

Same as above, nickel plate.

#658N **\$7.95** each

Lyre Collar Insignia: gold plate, clutch back.

#659G **\$13.95** pair

“You got it right!

“Semper Fi””

Cpl. C. Frey, PA

Pins



Marine Corps
#7795
(actual size)

U.S. Marine Corps Hat/Lapel Pin

1 1/2" diameter.

#7795

\$4.95 each

U.S. Marine Corps
#138MC



U.S. Marine Corps and U.S. Flags Pin

Etched enameled pin with
rubber clutch back.

1" W x 3/4" H

#138MC **\$3.95** each



oorAH! Pin

“Oorah!” – an expression of eliteness,
esprit de corps, and of anything good and
distinctly Marine Corps. With USMC Eagle/
Globe/Anchor. 1" W x 1 1/4" H

#988

\$3.95 each



“Semper Fi” Pin

7/8" W x 1" H

#987 **\$3.95** each



Insignia

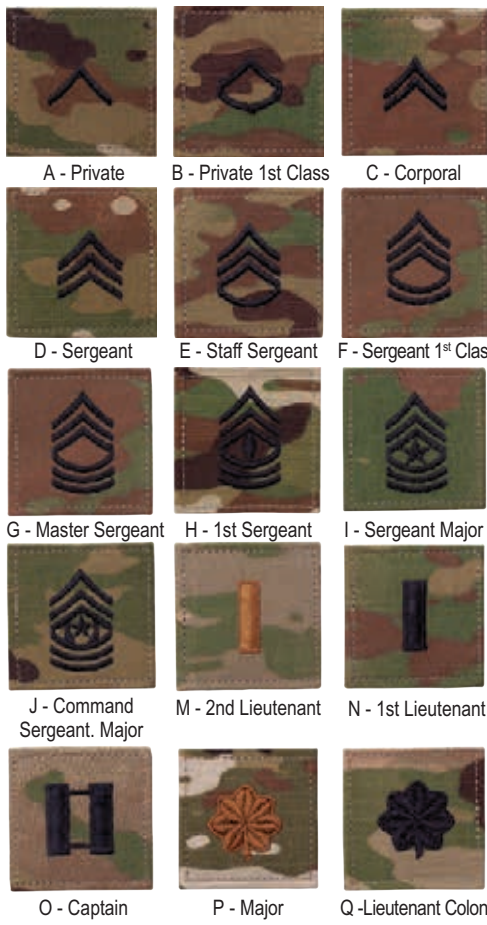

A - Private B - Private 1st Class C - Corporal
 D - Sergeant E - Staff Sergeant F - Sergeant 1st Class
 G - Master Sergeant H - 1st Sergeant I - Sergeant Major
 J - Command Sergeant Major M - 2nd Lieutenant N - 1st Lieutenant
 O - Captain P - Major Q - Lieutenant Colonel
 R - Colonel OCP

Scorpion OCP Rank 
 Easy-attach hook backing. Made to military specifications. Indicate Rank OCP #7050 **\$4.75** each

- A - Private
- B - Private 1st Class
- C - Corporal
- D - Sergeant
- E - Staff Sergeant
- F - Sergeant 1st Class
- G - Master Sergeant
- H - 1st Sergeant
- I - Sergeant Major
- J - Command Sergeant Major
- K - Spec4 (not shown)
- M - 2nd Lieutenant
- N - 1st Lieutenant
- O - Captain
- P - Major
- Q - Lt Colonel
- R - Colonel
- W1 - CW1 (not shown)
- W2 - CW2 (not shown)
- W3 - CW3 (not shown)
- W4 - CW4 (not shown)
- S - BG (not shown)



ABU Custom Digital and OCP Camo Tape
 Letters are dark blue on digital camo background with hook backing. 15 letters max. Submit names in writing. Please allow 10 business days for customizing.
 #ABUTAPE Custom **\$5.25** each
 #OCTAPE-ARMY Custom **\$5.25** each

Visit paradestore.com to see the complete selection of Army OCP insignia and patches.

Cap Devices



Army Officer Regulation Cap Device #751 Warrant Officer Cap Device #752 Army Enlisted Cap Device #705

Army Officer Cap Insignia
 Army Officer Regulation Cap Device: Gold plate, screw back. #751 **\$13.50** each
 Warrant Officer Cap Device: Gold plate, screw back. #752 **\$11.50** each

Army Enlisted Cap Insignia
 Gold plate, tarnish resistant, high luster, screw back.
 Army Enlisted Cap Device: #705 **\$12.50** each

 = PERMANENT SHINE. No polish! Gently wipe with clean, soft cloth.

Army Officer Swords and Sabers

We carry world-famous Weyersberg, Kirschbaum & Co. (WKC) Swords and Sabers. Turn to page 16 to learn more about these extraordinary weapons.

- Regulation Army Officer Saber
- West Point Military Style Sword



Army Ceremonial Belt  
 Complete belt with Coat of Arms emblem on gold-plated buckle, plus catch and lace keepers. Adjustable to 50".
 Army Belt #8151 **\$89.95** each

“Just keep doing what you already do so well. Thanks.”
 R.B., IN

HOOAH! Pins

HOOAH! and MEGA HOOAH! Pins
 Gold on black enamel.
 HOOAH! Pin 1 1/4" x 3/8" #978 **\$3.50** each
 MEGA HOOAH! Pin 1 1/4" x 3/4" #979 **\$3.50** each



Learn more on page 16

Aim High: Top Quality in Every Detail



USAF Regulation Honor Guard Ceremonial Belt, Officer #8157



USAF Regulation Honor Guard Ceremonial Belt, Officer



Complete with nickel buckle with Coat of Arms, catch, and keepers. Adjustable to 50".

USAF Belt, Officer #8157 **\$109.75** each

USAF Honor Guard Ceremonial Belt, Enlisted



Complete belt with Hap Arnold emblem on nickel buckle, plus catch and nickel keepers. Adjustable to 50".

USAF Belt, Enlisted #8172 **\$109.75** each



USAF Honor Guard Ceremonial Belt, Enlisted #8172

Air Force Collar Insignia



Both insignia are never-polish, wipe-clean bright nickel.

Officer's "U.S." letters #714AF **\$11.50** pair

Enlisted "U.S." letters in ring (not shown) #713AF **\$11.95** pair



Officer Pin #714AF

Hap Arnold Buttons #3029

Hap Arnold Buttons

HG Jacket Buttons #3029 **\$18.50** set of 3
 HG Epaulet Buttons #3029EP **\$9.25** pair
 Service Jacket Buttons #3019 **\$8.95** set of 3



#71417



Base Honor Guard Breast Badge

White #71417 **\$18.50** each

#71415



Base Honor Guard Patches

Full Color #71415 **\$6.95** each



Turn to page 92 for more custom flags and banners.

Customizable Air Force Guidon

Customizable Regulation Air Force Guidon. Single Reverse construction. Pole hem with leather tabs. Appliqued/Embroidered Design on nylon #AFGUIDON 20" x 2734" **\$339.00**



#638R

USAF Regulation Honor Guard Cord

Silver luminette with Hap Arnold tip and barrel and pin attachment.

Honor Guard Cord, Enlisted #638R **\$83.25** each
 Honor Guard Cord, Officer #638RO **\$76.25** each



Base Honor Guard Arc Tab #71412 **\$5.25** each



USAF Honor Guard Arc Tab #71411 **\$5.25** each



"Had to call to return an item I ordered by mistake. Excellent customer service. Thank you"

A.C., HI



The National Museum of the United States Air Force™

Welcome to the oldest—and largest—military aviation museum in the world! Visitors to the National Museum of the U.S. Air Force on the Wright-Patterson Air Force Base near Dayton, Ohio are awed by the size and scale of this museum's offerings. Whether you are interested in the early pioneers of flight or the latest advances in space travel, the USAF has you covered.

Starting as a small engineering study collection in 1923, the National Museum of the USAF is now a world-renowned center for air and space power technology and culture preservation. The collection is simply stunning and includes more than 350 aerospace vehicles and missiles and thousands more one-of-a-kind artifacts.

The museum is home to countless one-of-a-kind objects. Our once small engine collection now includes more than 350 aerospace vehicles and missiles, thousands of artifacts, and covers 20 indoor acres. In addition to flight-related objects from our past, you'll find incredible sensory exhibits that connect the Wright brothers' legacy with today's precision technology. There are aircraft, engines, equipment and weapons of the USAF galore.

That's not all. You could spend an entire day touring the outdoor exhibits alone! The museum's Memorial Park honors Air Force-associated people and units for their past service and sacrifice in the cause of freedom. From the first memorial dedicated to Americans held as prisoners of war by the North Vietnamese and those missing in action during the Southeast Asia War in 1972, the park now contains than 620 memorials, including statues, plaques, trees and benches. In addition to the memorials, there is a replica 8th Air Force Control Tower like those used by the U.S. Army Air Forces and Royal Air Force units at various air bases in Great Britain, allowing air traffic control personnel to direct aircraft takeoffs and landings at the field. Next to the Control Tower, the Nissen Hut portrays a 1940s bar and briefing room of an Army Air Corps Fighter Escort Squadron stationed in England. Stepping inside is like stepping into WWII history!

Planning Your Visit

The National Museum of the United States Air Force is open 9 a.m. to 5 p.m., seven days a week with free admission and parking.

Did you like this story? For more history, insight, and coupons, sign up for our newsletter, the Bugler, today at www.paradestore.com/aboutus

Air Force Cap Devices

Screw back Cap Devices for honor guard, officers and enlisted men and women. Bright nickel that never needs polishing, just wipe clean with soft cloth.



Honor Guard Hap Arnold #709 **\$11.95** each



Hap Arnold Beret Device
Bright Nickel #709S **\$9.95** each



Officer #710AFB **\$13.50** each



Enlisted #712AFB **\$12.25** each



PERMANENT SHINE.
No polish! Gently wipe with clean, soft cloth.

USAF Cap Straps

Wear leather cap straps down as chinstraps to keep in place during ceremonies, continuous drill movements, or in adverse conditions. Service Cap Straps, Plain (or flat) black



Honor Guard Cap Strap, silver #3032 **\$14.95** each



Service Cap Strap, plain black #3033 **\$7.95** each



Honor Guard Cap Back Strap, black gloss patent leather #3034 **\$9.50** each

USAF Silver Braid, 3/4" (shown actual size)



Order in multiples of 36 yards. Allow 3-4 weeks for delivery.

Silver Braid #71418 **\$449.00** for each 36-yard roll

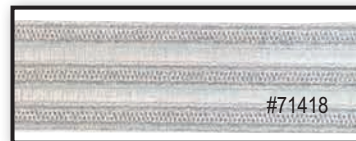

Dress Cap Protective Cover

Protect your military dress cap with a lightweight and compact black nylon cover that is easy to transport and a cinch to store. Updated with an easy access ID plate. For military, police, and fire service personnel worldwide. Round male cover is 6.7 oz., 12" diameter. Oval female cover is 7.3 oz., 12 1/2" x 10 1/2". Black. Hand wash; air dry.

Dress Cap Protective Cover,
Male #517 **\$34.95** each
Female #518 **\$34.95** each



Dress Cap Protective Cover, #517



Cap Button #3028B

USAF Service Cap #3028

USAF Service Cap

Regulation Service Cap with plain visor.



- Sizes: 6 1/2, 6 5/8, 6 3/4, 6 7/8, 7, 7 1/8, 7 1/4, 7 3/8, 7 1/2, 7 5/8, 7 3/4, 7 7/8 #3028 **\$84.95** each
- Size: 8 #30288 **\$84.95** each
- Replacement Service Cap Button and Screw #3028B **\$6.50** each

Bernard Cap Company — the only headwear company to be awarded the Department of Defense Quality Excellence Award — represents quality and craftsmanship. We're proud to offer their Air Force Caps.

Shop rain cap covers on page 48.



Cap Button #3027B

USAF Honor Guard Cap #3027



USAF Honor Guard Cap

Regulation Service Cap with silver-edged visor. Enlisted and Company Grade.



- Sizes: 6 1/2, 6 5/8, 6 3/4, 6 7/8, 7, 7 1/8, 7 1/4, 7 3/8, 7 1/2, 7 5/8, 7 3/4, 7 7/8 #3027 **\$109.95** each
- Size: 8 #30278 **\$109.95** each
- Replacement Honor Guard Cap Button and Screw #3027B **\$6.50** each

USAF Cap Sizes and Equivalents

TO DETERMINE CAP SIZE: With a cloth measuring tape, measure completely around the head. Position the tape above the ears where you wish to wear the cap. Find your measurement below and the corresponding hat size.

6 1/2 — 20 1/2"	6 7/8 — 21 5/8"	7 1/4 — 22 3/4"	7 5/8 — 23 1/8"
6 5/8 — 20 7/8"	7 — 22"	7 3/8 — 23 1/8"	7 3/4 — 24 1/4"
6 3/4 — 21 1/4"	7 1/8 — 22 3/8"	7 1/2 — 23 1/2"	8 — 25"

We Share Your Commitment to Excellence



#513

Service Cap Carrier

Finally, a hard service cap carrier that protects and preserves any style service cap in any size—another product customers asked for that we were pleased to develop with the manufacturer! Inside this hard plastic carrier, an adjustable mount and a soft foam block to hold cap in place when case is closed. With two lockable latches, the case can be flown as checked baggage or taken on board as a carry-on. 14"W x 15"H x 7 7/8"D. Black only. For another way to protect Service Caps, see our Flannel Helmet Bag on page 45.

- Cap Carrier #513 **\$74.95** each*

*Add \$7 additional shipping if shipped to the lower continental US. Add \$15 each outside the lower continental US. See page 81 for complete shipping information.



#505

#506

The CoverBag

Protect your service cap or Bell Crown Cap (Choose the larger, Male CoverBag for a Bell Crown cap) with this water-resistant nylon carrying case that's convenient, comfortable and easy to transport. It has reinforced walls, a leather handle and a strap that fits over a roller case handle. Interior and exterior pockets will hold gloves and keys or phone. When not in use, it's fully collapsible. Available in two styles, black only: either as a plain bag or one with two black loop panels to hold patches with a hook backing. One 2 3/4"-square loop fastener is sewn on the front panel to accommodate a 4" patch. There is also a 2 3/4" x 2" loop fastener on the side pocket. The larger male size is 11" W x 12" H x 6" D. The smaller female size is 10" W x 10 1/2" H x 6" D.

- Male, plain #504 **\$49.95** each
- Female, plain #505 **\$49.95** each
- Male, with loop panel #506 **\$59.95** each

For Garment and Gear Bags, see pages 46-47

Hat/Collar/Lapel Pins

All pins are double clutch back and shown actual size: 1 3/4" x 3/8". **\$3.75** each

glendale
exclusive

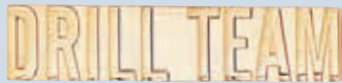

Drill Team #786B Brass



Drill Team #786N Nickel



Rifle Team #787B Brass



Rifle Team #787N Nickel



Honor Guard #785B Brass



Honor Guard #785N Nickel



Color Guard #788B Brass



Color Guard #788N Nickel

“Thanks a million for the excellent quality and service.”

D.T., Las Vegas, NV



Saber Team #960



Rifle Team #961



Rifle Team #989

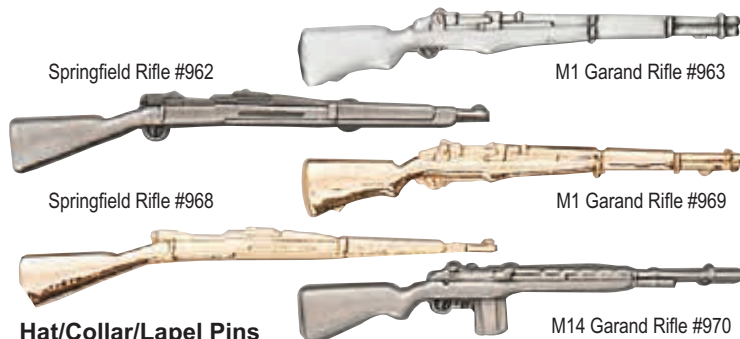

Hat/Collar/Lapel Pins for Drill Units

Pins above are double clutch back. **\$4.95** each
 Rifle Team Springfield Rifle in antique silver finish, 2 1/2". #962
 Rifle Team Springfield Rifle in goldtone finish, 2 1/2". #968
 Rifle Team M1 Garand Rifle in antique silver finish, 2 3/8". #963
 Rifle Team M1 Garand Rifle in goldtone finish, 2 3/8". #969
 Rifle Team M-14 in antique silver finish, 2 3/8". #970

Hat/Collar/Lapel Pins for Drill Units

Pins above are double clutch back. **\$3.95** each
 Saber Team Crossed Sabers in goldtone finish, 1". #960
 Rifle Team Crossed Rifles in goldtone finish, 1 1/2". #961
 Rifle Team Crossed Rifles in black finish, 1 1/2". #989



U.S. Army #132A



U.S. Air Force #132AF



U.S. Navy #132N



U.S. Marine Corps #132MC

Armed Forces Pins with Flags

Armed Forces emblems with U.S. flags. Etched enameled pins, epoxy coated, clutch back, 7/8" W x 1 1/8" H. All **\$4.95** each

Military Hat/Lapel Pins

1 1/2" diameter. All pins are clutch back. **\$4.95** each



Navy #7793



Coast Guard #7797



Marine Corps #7795 (actual size)



Army #7790



Army National Guard #7791



Air Force #7792

Veterans' Organization Lapel Pins

All pins are clutch back. **\$3.95** each



Commander 1 1/4" x 3/8" #139A



District Commander 1 1/4" x 1/2" #139C



Senior Vice Commander 1 1/4" x 3/8" #139E



Quartermaster 1 1/2" x 3/8" #139G



Sergeant at Arms 1 1/4" x 3/8" #139I



Life Member 1 1/4" x 3/8" #139K



Past Commander 1 1/4" x 3/8" #139B



Past District Commander 1 1/4" x 3/4" #139D



Junior Vice Commander 1 1/4" x 1/2" #139F



Finance Officer 1 1/8" x 5/8" #139H



Adjutant 1 1/4" x 1/2" #139J



Chaplain 1 1/8" x 3/8" #139L (actual size)



Metal Arc Pins

All pins are a shiny gold metal with bright, colorful enamel and double clutch back. Shown actual size: 1 1/8" x 7/16". **\$5.95** each



Leadership — black
#868



Honor Roll — royal
#856



JCLC — brown
#874



Drill Team — scarlet
#851



L.O.T.C. — royal
#876



Academics — yellow
#857



Sabre Team — white
#862



Color Guard — white
#853



Rifle Team — olive
#852



Orienteering — kelly green
#858



Sabre Guard — gold
#865



Staff — lt. blue
#869



Cadet Challenge — white
#870



Regulation — burgundy
#859



Rappelling — black
#863



Honor Guard — cream
#850



Recondo — white
#871



P.T. Team — black
#860



Flag Detail — royal
#864



Honor Guard — orange
#873



Sail Team — royal
#872

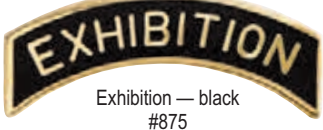

Exhibition — black
#875



Drum & Bugle — royal
#866



Raider — black
#855



Band — royal
#854



Summer Camp — brown
#861



Drum Corps — royal
#867



PT Excellence — black
#881



Archery — yellow
#879

Veterans' Hat/Lapel Pins

All pins are clutch back. Shown actual size.



"Semper Fi" Pin
7/8" W x 1" H
#987 **\$3.95** each



America is #1 Thanks to our Veterans, 7/8" W x 1" H
#1046 **\$3.95** each



Armed Forces Emblems with U.S. Flags

Etched enameled pins with rubber clutch backs, 1" W x 3/4" H. All **\$3.95** each

U.S. Army
#138A

U.S. Air Force
#138AF

U.S. Coast Guard
#138CG

U.S. Navy
#138N

U.S. Marine Corps
#138MC



"Once a Marine, Always a Marine" Pin
3/4" W x 1" H
#986 **\$3.95** each



Eagle with Flag 3/4" W x 1 1/8" H
#1048 **\$3.95** each



U.S. Flag/Veteran Pin
7/8" W x 7/8" H
#1045 **\$3.95** each



Hap Arnold Emblem Pin
1" W x 1" H
#990 **\$3.95** each



US Flag Lapel Pin
7/8" W x 3/4" T
#1838 **\$2.95** each



Color Guard Pin
Words only in red/white/blue
1 1/2" W x 5/8" H
#940 **\$4.25** each



Honor Guard Pin
Words only in red/white/blue
1 1/2" W x 5/8" H
#941 **\$4.25** each

We have more Honor and Color Guard Pins on page 51.

Ribbon Attachments

Shown actual size.
Most are 1/8" x 3/4".



#2061



#2062



#2063



#2064



#2065



#2066

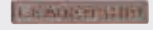

#2067



#2068



#2069



#2070 #2071



#2072

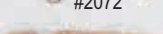

#2073

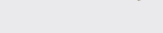
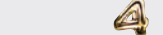
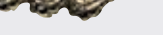
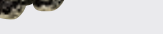
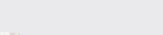
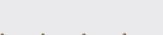
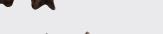
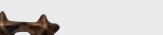
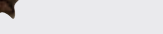
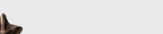
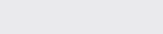
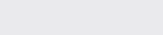
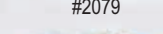
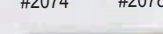
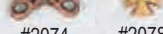
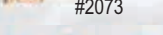

To add attachments, push the attachment through the ribbon then fold over the prongs to secure.

Ribbon Attachments

Available in bronze, silver or gold finish. Please order by combining item number and desired finish (for example: #2061BRNZ, #2061SILV or #2061GOLD).

Academic	#2061	\$3.50	each
Band	#2062	\$3.50	each
Color Guard	#2063	\$3.50	each
Drill Team	#2064	\$3.50	each
Honor	#2065	\$3.50	each
Honor Student	#2066	\$3.50	each
Leadership	#2067	\$3.50	each
Rifle Team	#2068	\$3.50	each
Saber Team- bronze only	#2069	\$3.50	each
Anchor	#2070	\$3.50	each
Crossed Rifles	#2071	\$3.50	each
Crossed Pistols	#2072	\$3.50	each
Rifle	#2073	\$3.50	each
Crossed Sabers	#2074	\$3.50	each
Maltese Cross	#2078	\$3.50	each
Honor Guard	#2079	\$3.50	each
Pilot Wings	#2080	\$3.50	each
"M": bronze	#2056	\$3.50	each
"W" silver	#2081	\$3.50	each
Eagle, globe & anchor	#2082	\$3.50	each
"E" gold or silver	#2057	\$3.50	each

Ribbon Attachments

Glendale goes the extra mile to offer ribbon mounts that are well crafted down to the final detail.

Stars: bronze, silver, gold

single	#2040R	\$1.35	each
double	#2041R	\$1.95	each
triple	#2042R	\$2.95	each
quad	#2043R	\$3.25	each

Arrowhead:

bronze	#2044R	\$2.95	each
--------	--------	--------	------

Oak Leaf Clusters: bronze, silver, gold

single	#2045R	\$1.35	each
double	#2046R	\$1.95	each
triple	#2047R	\$2.95	each
quad	#2048R	\$3.25	each

Numerals 0-9: bronze or gold finish

	#2055	\$2.95	each
--	-------	--------	------

Please order by complete number: for example, #2040RBRNZ or #2046RSILV or #20559GOLD instead of 2055GOLD to indicate numeral ordered.

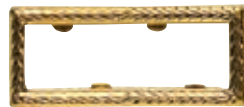

Army Frame, #A25



Air Force Frame, #AF25

Unit Citation Frames

Army frame: gold plate	#A25GILT	\$3.50	each
Air Force frame: gold plate	#AF25GILT	\$3.50	each



Klench Fasteners, brass #2162



Klench Fasteners, brass with protective clear back #2163

Klench Fasteners

Both fasteners have the same strong holding capability—the magic is in the urethane membrane. The fasteners with a clear back have a flexible protective back and will accept a longer pin backing on insignia, name tags and ribbon bars and hold them flush to the surface of the uniform. Neither will cause skin abrasion. Sold in a packaged set of 6.

Brass	#2162	\$6.50	per set of 6
Brass with protective clear back	#2163	\$6.50	per set of 6



Military Clutches #2060



Hold-Tight Pin Keepers

As the name implies, you'll never lose another pin with these trusty metal keepers. Each bag includes 10 keepers and an Allen wrench. Pins not included.

Hold-Tight Pin Keepers	#2090	\$7.25	per bag
------------------------	-------	--------	---------

Military Clutches, Brass

Set of 10 Clutches	#2060	\$1.35	per set
--------------------	-------	--------	---------



Mil-Enforcer Ribbon Support Kit

Helps reinforce and safeguard ribbon awards, badges, and insignia from drooping, sagging, and catching to achieve a professional appearance in any uniform.

3 Piece Kit	#RIBKIT	\$9.75	each
-------------	---------	--------	------



Mega Ribbon Kits

Mount 4-32 ribbons, 4 across, with this easily-assembled DIY ribbon kit. The mount is clear plastic and is packaged complete with ten prongs and military clutches, a red plastic anvil to support the mount when attaching the prongs, a cutting blade and instruction booklet. Available with no spacing or 1/8" spacing.

No spacing	#GKIT	\$11.50	each
1/8" spacing	#HKIT	\$11.50	each

Ribbon Mounts

Metal Ribbon Mounts

These contoured Uni-mounts are for standard metal ribbon mounts and right staggered ribbon mounts for the left collar. Single, Double and Triple mounts are made of brass, all other mounts are made of durable but lightweight stainless steel.

Standard Metal Ribbon Mounts **BEST SELLER!**

All ribbon holders are center mount and include clutches.

Right Staggered Metal Ribbon Mounts

These multiple ribbon mounts are staggered to fit around a lapel, so all ribbon awards will show. Includes clutches.

Standard Plastic Ribbon Mounts

Unlike metal mounts, these flexible mounts contour to the shape of the body. In fact, they will bend to 90° and still revert back to original shape. All ribbon holders are center mount and include clutches.

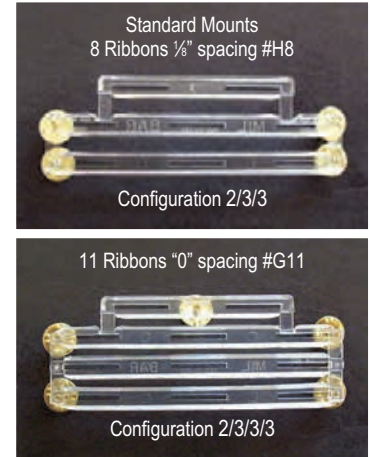
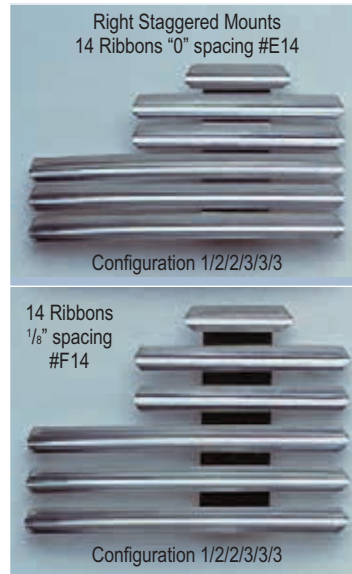
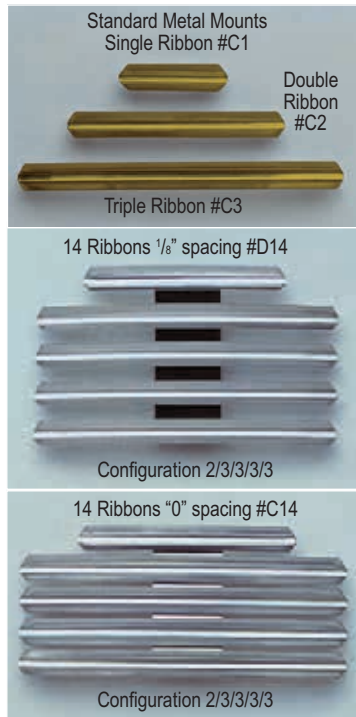

Air Force and Navy Ribbon Mounts - "0" spacing
 Army Ribbon Mounts - 1/8" spacing
 Marine Corps Ribbon Mounts - either "0" or 1/8" spacing

Ribbon Mounts		Standard Metal BEST SELLER!		Right Staggered Metal		Standard Plastic	
Number of Ribbons displayed	Ribbons/Bar Configuration for standard mounts	C: "0" spacing	D: 1/8" spacing	E: "0" spacing	F: 1/8" spacing	G: "0" spacing	H: 1/8" spacing
1	1	#C1 \$0.95					
2	2	#C2 \$1.10					
3	3	#C3 \$1.25				#G3 \$1.95	
4	1/3	#C4 \$3.75	#D4 \$3.75			#G4 \$3.50	#H4 \$3.50
5	2/3	#C5 \$3.75	#D5 \$4.50			#G5 \$3.50	#H5 \$3.75
6	3/3	#C6 \$3.75	#D6 \$4.50			#G6 \$3.75	#H6 \$3.75
7	1/3/3	#C7 \$4.50	#D7 \$4.50			#G7 \$3.75	#H7 \$3.95
8	2/3/3	#C8 \$4.50	#D8 \$4.75			#G8 \$3.75	#H8 \$4.25
9	3/3/3	#C9 \$4.50	#D9 \$4.75	#E9 \$4.25	#F9 \$4.75	#G9 \$3.75	#H9 \$4.25
10	1/3/3/3	#C10 \$4.50	#D10 \$4.95	#E10 \$4.50	#F10 \$4.95	#G10 \$4.25	#H10 \$4.50
11	2/3/3/3	#C11 \$4.75	#D11 \$4.95	#E11 \$5.95	#F11 \$5.50	#G11 \$4.50	#H11 \$4.75
12	3/3/3/3	#C12 \$4.95	#D12 \$5.25	#E12 \$5.95	#F12 \$5.50	#G12 \$4.50	#H12 \$4.75
13	1/3/3/3/3	#C13 \$5.25	#D13 \$5.25	#E13 \$6.25	#F13 \$5.50	#G13 \$4.75	#H13 \$5.25
14	2/3/3/3/3	#C14 \$5.50	#D14 \$5.75	#E14 \$6.25	#F14 \$5.50	#G14 \$4.95	#H14 \$5.75
15	3/3/3/3/3	#C15 \$5.50	#D15 \$5.95	#E15 \$6.25	#F15 \$5.75	#G15 \$5.25	#H15 \$5.75
16	1/3/3/3/3/3	#C16 \$5.75	#D16 \$6.50	#E16 \$6.25	#F16 \$6.25	#G16 \$5.50	#H16 \$5.75
17	2/3/3/3/3/3	#C17 \$6.25	#D17 \$6.50	#E17 \$7.25	#F17 \$6.25	#G17 \$5.50	#H17 \$5.95
18	3/3/3/3/3/3	#C18 \$6.50	#D18 \$6.50	#E18 \$7.25	#F18 \$6.50	#G18 \$5.75	#H18 \$6.25
19	1/3/3/3/3/3/3	#C19 \$6.50	#D19 \$6.75	#E19 \$7.25	#F19 \$6.75	#G19 \$5.75	#H19 \$6.50
20	2/3/3/3/3/3/3	#C20 \$6.75	#D20 \$7.25	#E20 \$7.50	#F20 \$6.75	#G20 \$6.25	#H20 \$6.75
21	3/3/3/3/3/3/3	#C21 \$6.95	#D21 \$7.25	#E21 \$7.50	#F21 \$6.75	#G21 \$6.50	#H21 \$6.75
22	1/3/3/3/3/3/3/3	#C22 \$7.25	#D22 \$9.75	#E22 \$7.50	#F22 \$9.75	#G22 \$6.50	#H22 \$8.50
23	2/3/3/3/3/3/3/3	#C23 \$7.50	#D23 \$10.25	#E23 \$9.95	#F23 \$9.75	#G23 \$6.75	#H23 \$8.75
24	3/3/3/3/3/3/3/3	#C24 \$7.50	#D24 \$10.25	#E24 \$10.25	#F24 \$9.75	#G24 \$6.75	#H24 \$9.75
25	1/3/3/3/3/3/3/3/3	#C25 \$8.25	#D25 \$10.25	#E25 \$10.25	#F25 \$10.25	#G25 \$7.25	#H25 \$10.25
26	2/3/3/3/3/3/3/3/3	#C26 \$8.75	#D26 \$10.75	#E26 \$10.75	#F26 \$10.75	#G26 \$7.50	#H26 \$10.25
27	3/3/3/3/3/3/3/3/3	#C27 \$9.25	#D27 \$10.75	#E27 \$11.50	#F27 \$10.75	#G27 \$9.50	#H27 \$10.75
28	1/3/3/3/3/3/3/3/3/3	#C28 \$9.95	#D28 \$11.25	#E28 \$11.95	#F28 \$11.25	#G28 \$10.50	#H28 \$11.25
29	2/3/3/3/3/3/3/3/3/3	#C29 \$10.25	#D29 \$11.75	#E29 \$11.95	#F29 \$11.50	#G29 \$11.50	#H29 \$11.50
30	3/3/3/3/3/3/3/3/3/3	#C30 \$10.75	#D30 \$11.95	#E30 \$11.95	#F30 \$11.95	#G30 \$12.95	#H30 \$11.95
31	1/3/3/3/3/3/3/3/3/3/3	#C31 \$10.75	#D31 \$12.25	#E31 \$11.95	#F31 \$12.25	#G31 \$13.50	#H31 \$12.25
32	2/3/3/3/3/3/3/3/3/3/3	#C32 \$10.75	#D32 \$12.50	#E32 \$11.95	#F32 \$12.50	#G32 \$13.50	#H32 \$12.50

4-32 See page page 70 for our Do-It-Yourself Mega Ribbon Kits.



Meet the Chief Master Sergeant of the Air Force

Joanne S. Bass, the 19th Chief Master Sergeant of the Air Force, is focused on giving the men and women of today's Air Force the tools and skills they need to face the most challenging environments the force has ever faced.

An inspiring leader whose major awards include the Legion of Merit, Meritorious Service Medal with four oak leaf clusters and the Joint Service Commendation Medal among many, many more, Chief Bass enjoys meeting with Airmen in Training and Senior Enlisted leaders alike to define the challenges ahead and inspire every one of them to become an expert in their field of expertise.





























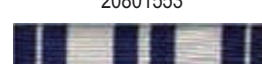
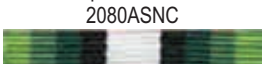
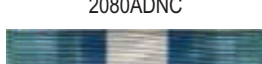

"We need leaders at all levels who can think strategically, and execute tactically. To that end, I'm bringing you a reading list that will flex and evolve as we build the Air Force we need to compete, deter and win across all domains."

— Joanne S. Bass

Serving at the highest noncommissioned officer position, Chief Master Sergeant Bass is the personal adviser to the Chief of Staff and the Secretary of the Air Force on all issues regarding the welfare, readiness, morale, and proper utilization and progress of more than 600,000 men and women who serve in the force.



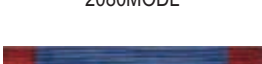
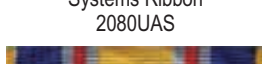

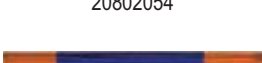
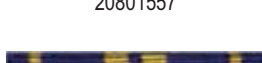
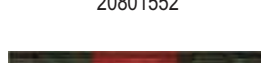
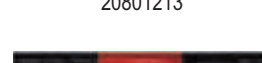
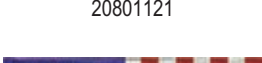
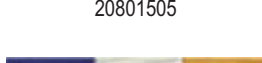

















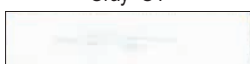
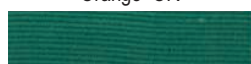







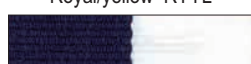



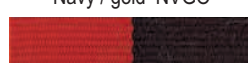
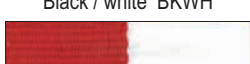

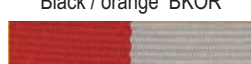
Did you like this story? For more history, insight and coupons, sign up for our newsletter, the *Bugler*, today at www.paradestore.com/aboutus

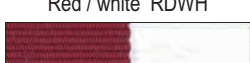
Air Force and Space Force JROTC Ribbon Chart

			
Gold Valor Award 20801140	Silver Valor Award 20801149	Cadet Humanitarian Award 2080CHA	Community Service with Excellence Award 2080CSEA
			
Distinguished Unit with Merit Award 2080DUWM	Distinguished Unit Award 20801340	Outstanding Organization Award 2080OOA	Outstanding Flight Ribbon 20801106
			
Top Performer Award 20801338	Outstanding Cadet Ribbon 2080OUTC	Leadership Ribbon 2080LEAD	Superior Performance Ribbon 2080SUPP
			
Achievement Ribbon 2080ACHV	Academic Ribbon 2080ACAD	Cadet Leadership Course Ribbon 20801487	Special Teams Placement Ribbon 20801553
			
All Service National Competition Ribbon 2080ASNC	Air Force Nationals Competition Ribbon 2080ADNC	Orienteering Ribbon 20801225	Leadership Development Requirement Ribbon 2080COAL
			
Drill Team Ribbon 2080DRTM	Color Guard Ribbon 2080COLG	Sabre Team Ribbon 2080SABR	Marksmanship Ribbon 2080MARK
			
JLAB Ribbon 2080JLAB	Cyber Patriot Ribbon 2080CYBER	StellarXplorers Ribbon 2080EXP	Raiders Team Ribbon 2080RAIDER
			
Military Model Building Ribbon 2080MODL	Unmanned Aircraft Systems Ribbon 2080UAS	Robotics Ribbon 2080ROBO	Good Conduct Ribbon 20801110
			
Service Ribbon 20802054	Health and Wellness Ribbon 20801557	Recruiting Ribbon 20801552	Activities Ribbon 20801213
			
Attendance Ribbon 20801121	Dress and Appearance Ribbon 20801505	Longevity Ribbon 20804059	Bataan Death March Memorial Hike Ribbon 2080BDMM
		Air Force and Space Force JROTC Ribbon Slides Regulation ribbon awards, slide only, made in USA. See list of all ROTC and JROTC awards on our web site at www.paradestore.com . Order by name of award, adding to end of product number. Ribbon Slides \$1.35 each.	
Patriotic Flag Ribbon 2080PATR	Resiliency Ribbon 2080COVD		

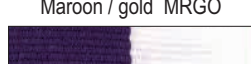
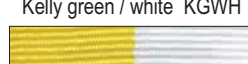
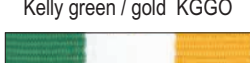
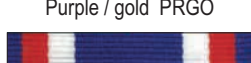
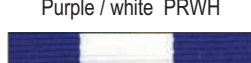
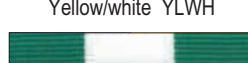
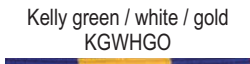
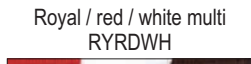
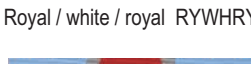
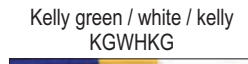
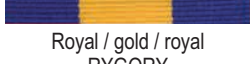
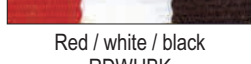
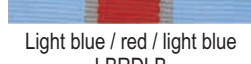

Visit ParadeStore.com for our complete selection

 Rainbow RAIN	 Stars & Stripes SS	 Royal RY	 Red RD
 Maroon MR	 Light blue LB	 Navy blue NV	 Gold GO
 Gray GY	 Orange OR	 Black BK	 Purple PR
 White WH	 Kelly green KG	 Light blue / white LBWH	 Royal / white RYWH
 Royal / red RYRD	 Royal / gold RYGO	 Royal / yellow RYYL	 Royal / kelly green RYKG
 Royal / gray RYGY	 Royal / orange RYOR	 Navy / white NVWH	 Navy / gold NVGO
 Black / white BKWH	 Black / gold BKGO	 Black / orange BKOR	 Red / black RDBK
 Red / white RDWH	 Red / gold RDGO	 Red / gray RDGY	 Red / kelly green RDKG
 Maroon / white MRWH	 Maroon / gray MRGY	 Maroon / gold MRGO	 Kelly green / white KGWH
 Kelly green / gold KGGO	 Purple / gold PRGO	 Purple / white PRWH	 Yellow / white YLWH
 Kelly green / white / gold KGWHGO	 Royal / red / white multi RYRDWH	 Royal / white / royal RYWHRY	 Kelly green / white / kelly KGWHKG
 Royal / gold / royal RYGORY	 Red / white / black RDWHBK	 Light blue / red / light blue LBRDLB	 Royal / gold / white RYGOWH
 Royal / white / red multi RYWHRD	 Red / white / royal blue RDWHRY	 Red / white / royal / metallic gold trim MGRDWHRY	 Pink for Breast Cancer Awareness PK

Ribbon Slides

Ribbon slides with stock ribbon in solid colors or combinations to match drapes on page 74. 1 1/2" x 3/8". To order, add color abbreviation to RBN15 or RBN16 (for example RBN15RAIN for Rainbow).

Ribbon slide posts and clutches.
#RBN15 **\$1.45** each



Ribbon back, slide, posts, and clutches

Ribbon slide only.

#RBN16 **\$1.35** each



Ribbon back, slide only (shown actual size)



JROTC, ROTC Ribbon Slides

Regulation ribbon awards, slide only, made in USA. See list of all ROTC and JROTC awards on our web site at www.paradestore.com. Order by name of award, adding to end of product number.

Ribbon Slides **\$1.35** each.
AFROTC #2081; AFJROTC #2080; MCJROTC #2083; NJROTC #2082
(For Army ROTC and JROTC ribbons, see page 56. For Air Force and Space Force, see page 72. For Navy and Marine Corps, see page 62.)

“Thank you so much for your phenomenal professional customer service and congeniality. Your excellence in helping our organization at a critical time; is heartwarming and positively overwhelming! Our crisis was averted by your expert service. As a result of your efforts; I will recommend this company to all those I know, that may need the services you all provide. We’ve been very pleased!”

*Reginald Washington,
CMSgt (Ret), USAF FL*



Stars and Stripes Ribbon #RBN15SS

The Stars and Stripes Medal
The drape with pin fastener holds an antique finish gold starburst medal, 1 1/2", with eagle.
Medal #SS1 **\$12.75** each

Stars 'n Stripes Ribbon
Clutch back.
Ribbon #RBN15SS **\$1.60** each



Stars and Stripes Medal #SS1



Stars and Stripes Pin #SS4

Stars 'n Stripes Pin
Enameled pin, 1 1/4".
Clutch back.
Enameled Pin #SS4 **\$5.25** each

Ribbon Drapes



Ribbon Drapes

Pin back ribbon drapes – size 1½" x 1⅞". Specify gold, silver, or bronze ring for RL1, RL5 and RL9 drapes.

All RL ribbon Drapes **\$2.75** each
All drapes have an attached ring.



#RL1
Red/white/royal

#RL17
Gold trim

#RL5
Rainbow

#RL9
Stars & Stripes

#RL21
Royal

#RL22
Red

#RL24
Light blue



#RL23
White

#RL25
Kelly

#RL26
Gold

#RL27
Yellow

#RL28
Orange

#RL29
Black

#RL210
Navy

#RL211
Purple

#RL214
Maroon



#RL216
Light blue/white

#RL217
Light blue/gold

#RL218
Royal/white

#RL219
Royal/red

#RL220
Royal/gold

#RL221
Royal/orange

#RL222
Royal/kelly

#RL223
Royal/gray

#RL224
Navy/white



#RL225
Navy/gold

#RL226
Black/white

#RL227
Black/red

#RL228
Black/gold

#RL229
Black/orange

#RL230
Red/white

#RL231
Red/gold

#RL233
Red/black

#RL234
Red/gray



#RL235
Red/kelly

#RL236
Maroon/white

#RL237
Maroon/gold

#RL238
Maroon/gray

#RL242
Orange/black

#RL243
Kelly/white

#RL244
Kelly/gold

#RL247
Purple/white

#RL248
Purple/gold

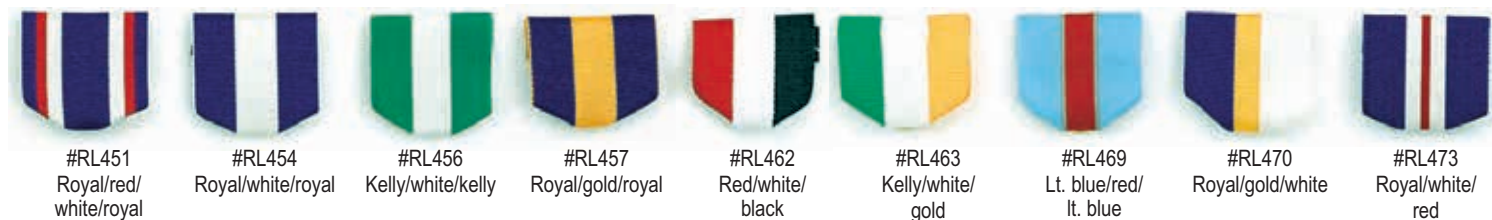

#RL451
Royal/red/
white/royal

#RL454
Royal/white/royal

#RL456
Kelly/white/kelly

#RL457
Royal/gold/royal

#RL462
Red/white/
black

#RL463
Kelly/white/
gold

#RL469
Lt. blue/red/
lt. blue

#RL470
Royal/gold/white

#RL473
Royal/white/
red



Ribbon Drape Bar Holder

Available in antique finish goldtone, silvertone, or bronzetone with two clutch backs. Measures 1½" x 1½".

Plain

Goldtone	#1049G	\$8.75 each
Silvertone	#1049S	\$8.75 each
Bronzetone	#1049B	\$8.75 each

Engraved

Goldtone	#1049GE	\$13.75 each
Silvertone	#1049SE	\$13.75 each
Bronzetone	#1049BE	\$13.75 each

Maximum number of characters for Engrave Bar Holder is 12. Submit customized engraving in writing.



Presentation Neck Ribbons

All drape colors shown above are available in 1½" x 30" neck ribbons, except for colors RL233 (Red/black) and RL235 (Red/kelly) and all ribbons in bottom row.

RP + number above	\$3.25 each
RP17 with gold trim	\$3.95 each

JROTC Ribbon Drapes (ND Series)

Regulation JROTC Ribbon Drape with pin and safety catch and gold ring. Order by number – for example, #NDG13 for N-1-3, Academic Achievement. There are 37 N-Series drapes. The ones shown here match the N-Series medals below. All others are shown online at www.ParadeStore.com

ND Series – Army JROTC

\$3.50 each.



N-Series Awards Medals

The N-Series Awards Medals, 1 1/2" diameter, are available in an antique gold finish with a gold ring to attach a drape. Some are designed to match the JROTC N-series ribbon drapes above, but all can be used on any drape of your choice – shown opposite. The N-Series Awards Medals are \$6.95 each without engraving. For 2 - 3 initials engraved on the reverse side, add \$5.00 for each medal. Submit engraving in writing.



Unique Medals Are a Snap



Medal shown actual size

Step 1

Choose a Ribbon Drape or a JROTC Ribbon Drape.

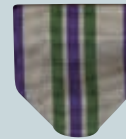

#NDG11 Distinguished Cadet

Step 2

Choose a medal or award from pages 75-78.



#N0011 Distinguished Cadet

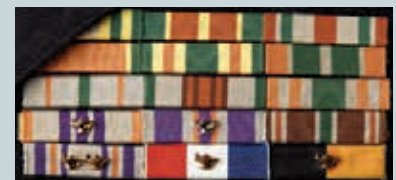

AROTC and AJROTC Ribbons

Regulation AROTC awards (R Series) and AJROTC awards (N Series). Order by number; for example, N11 for N-1-1, Distinguished Cadet. See full listing with pictures on our web site: www.paradestore.com.

#R Series \$1.35 each
#N Series \$1.35 each

A-Series Achievement Medals

Recognize citizenship and excellence with the A-Series Achievement Medals, 1 3/8" diameter, available in an antique gold finish. **\$6.50** each without engraving. For 2-3 initials engraved on the reverse side, add **\$5.00** for each medal. Submit engraving in writing.

All Glendale medals can be worn with any ribbon drape. Solid colors, two- and three-color combinations, and some Army JROTC drapes are shown on page 74 and page 75.



Medal shown actual size

“One of the best customer service I have received. Speed of delivery exceptional.”

D.L., Colorado springs, CO.

Reverse side of all medals



#A0001
Citizenship Award



#A0002
Perfect Attendance



#A0003
Leadership Camp



#A0004
Drum & Bugle Corps



#A0005
Band Excellence



#A0006
Flag Detail



#A0007
Sabre Team



#A0008
Raider Team



#A0009
Regulation Drill



#A0010
Best Squad Drill



#A0011
Best Company Drill



#A0012
Leadership Award



#A0013
Achievement Award



#A0014
Cadet NCO of the Quarter



#A0015
Cadet NCO of the Semester



#A0016
Cadet NCO of the Month



#A0017
Cadet NCO of the Year



#A0018
Outstanding Cadet NCO



#A0019
Cadet Officer of the Year



#A0020
Cadet Officer of the Month



#A0021
Cadet Officer of the Quarter



#A0022
Cadet Officer of the Semester



#A0023
Outstanding Cadet Officer



#A0024
Cadet of the Month



#A0025
Cadet of the Quarter



#A0026
Cadet of the Semester



#A0027
Cadet of the Year



#A0028
Most Improved Cadet



#A0029
Best First Year Cadet



#A0030
Cadet Commander



#A0031
Honor Roll



#A0032
National Honor Society



#A0033
Second Mile Award



#A0034
Military Merit



#A0035
Pathfinder



#A0036
Ranger



#A0037
Ranger Challenge



#A0038
Raider Challenge



#A0039
Cadet Challenge



#A0040
Efficiency Award



#A0041
Community Service Award



#A0042
Principal's Award



#A0043
Commandant's Award



E-Series Medals

For achievements that deserve high recognition, present an E-Series Medal. All medals are available in a gold (G), silver (S), or bronze (B) finish unless otherwise noted. Each is 1 1/4" diameter with an area for engraving on the back of 3/4". **\$5.25** each without engraving.

To add value and meaning to the award, each of these medals can be engraved on the reverse side for **\$5.00** per medal. Submit engraving in writing.

All Glendale medals can be worn with any ribbon drape. To see the complete selection of Army JROTC drapes visit us online at www.paradestore.com.



Medal shown actual size

Reverse side of all medals



#E9141G
In Honor of Academic Excellence



#E9004B
Scholastic Achievement



#E9231G
Star Performer (gold only)



#E9039G
Track, General



#E9041G
Female Track Runner



#E9043G
Male Track Runner



#E9070B
Rifle Shooter



#E9075G
Eagle with Torch



#E9133G
Eagle (gold and silver only)



#E9140G
Scholastic Achievement, (gold only)



#E9003G
Achievement



#E9152G
Achievement Recognition



#E9196G
Succeeding with Teamwork (gold only)



#E9208G
Leadership, (gold & silver only)



#E9255G
Outstanding Citizen



#E9301G
Distinguished Service Award, (gold only)



#E9428S
Crossed Rifles (silver and gold only)



#E9871G
First Place (gold only)



#E9882S
Second Place (silver only)



#E9893B
Third Place (bronze only)



#E4791G
Lamp of Learning



#E9951G
Outstanding Student (gold only)



#E9073G
Track Female Field Events



#E9163G
In Honor of Excellence (gold only)

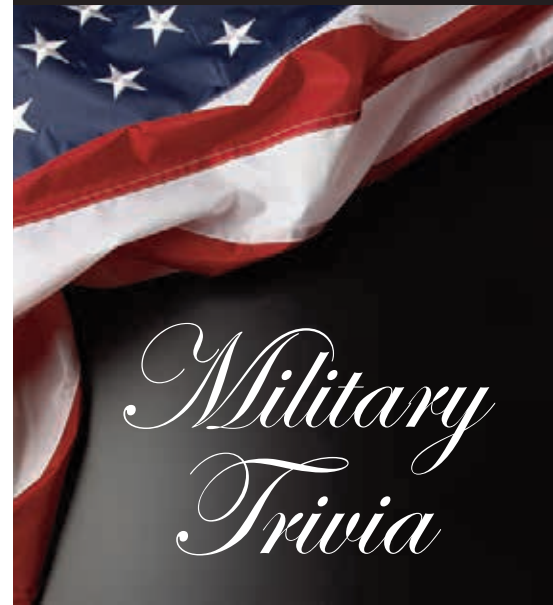

Test yourself!

We've compiled eight trivia questions about the U.S. military. Can you get a perfect score?

1. When referring to the test taken for entrance into the US military what does ASVAB stand for?
2. What is the highest enlisted rank a soldier can hold in the United States Army?
3. What is the call sign of any United States Marine Corps aircraft carrying the president of the United States?
4. In what year was the United States Air Force officially established as a separate branch of the military?
5. In what year was the United States Coast Guard established?
6. What is the code name for the US Navy SEALs' standard assault rifle?
7. What is the term for the smallest unit of a military organization, typically consisting of ten to thirty soldiers?
8. Who was the first female four-star general in the US Army?

Do you enjoy military history, insight, and coupons? Sign up for our newsletter, the *Bugler*, today at www.paradestore.com/aboutus

1. Armed Services Vocational Aptitude Battery. 2. Sergeant Major of the Army. 3. Marine One. 4. 1947. 5. 1790. 6. MK18. 7. Squad. 8. Ann E. Dunwoody.

Create Your Own Medals!

School and Organization Medals

All medals below are available in gold(G), silver (S), or bronze (B) tone. Inserts sold below.



Octagon, 1 1/16"
#S006
\$3.95 each
with insert \$6.45



"V" w/ flame,
1 3/4" #S007
\$6.25 each
with insert \$8.75
w/ 2 inserts \$11.25



Victory, 1 3/4"
#S423
\$5.50 each
with insert \$7.50



Victory, 1 5/8"
#S127
\$3.95 each
with insert \$6.45



Scholastic, 1 5/8"
#S117
\$3.95 each
with insert \$6.45



Honor Roll, 1 5/8"
#S195
\$4.25 each
with insert \$6.75



Citizenship, 1 5/8"
#S194
\$4.25 each
with insert \$6.75



Target, 1 5/8"
#S181
\$3.95 each
with insert \$6.45



Crossed Rifles,
1 5/8"
#S1200
\$4.25 each
with insert \$6.75



Excellence, 1 5/8"
#S133
\$3.95 each
with insert \$6.45



Plain Laurel, 1 5/8"
#S187
\$3.95 each
with insert \$6.45



Track, 1 5/8"
#S160
\$4.25 each
with insert \$6.75



Archery, 1 5/8"
#S142
\$4.75 each
with insert \$7.25

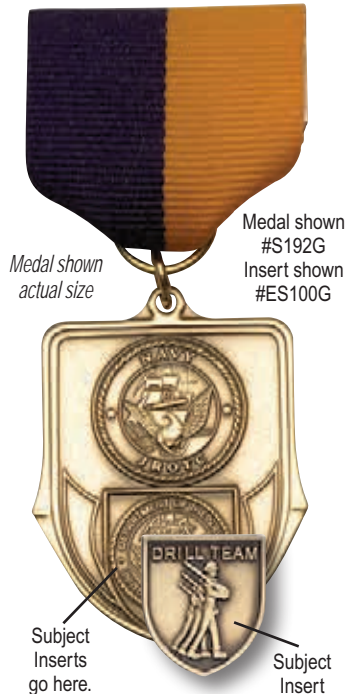

Medal shown
#S192G
Insert shown
#ES100G

Subject Inserts go here. Subject Insert

An honor that will last

Metals and inserts you can be proud to give, these are produced from top quality materials carefully selected for their metal integrity. To display a more specific message, place an insert into the shield where the "V" or laurel leaf symbol is located. Unless noted, all are available in gold, silver, or bronze tone. Because these medals do not require additional inserts, prices for medals and inserts are separate.

Engrave medals on the reverse side for \$5.00 per medal. Submit customized engraving in writing.



For ribbon drapes for each medal — in solid colors, two- and three-color combinations, and Army JROTC drapes — see pages 75-76.

JROTC Medals

All JROTC medals below are 1 1/8" W x 1 5/8" H. Available in gold, silver, or bronze tone. JROTC top seal; BOS on bottom shield. Inserts sold below are placed over shield, if desired.



Army JROTC
#S190
\$4.50 each
with insert \$7.00



AFJROTC
#S191
\$4.50 each
with insert \$7.00



Navy JROTC
#S192
\$4.50 each
with insert \$7.00



MCJROTC
#S193
\$4.50 each
with insert \$7.00

Glendale Exclusive Inserts glendale exclusive

Subject inserts for medals on this page are available in gold, silver, or bronze tone. \$2.50



#ES100
Armed Drill Team



#ES101
Honor Guard



#ES102
Color Guard



#ES103
Sabre Team



#ES104
JROTC



#ES105
PT Team



#ES106
Rifle Team



#ES107
Orienteering



#ES108
Unarmed Drill Team



#ES109
Excellence/Torch



#ES110
Leadership

Subject Inserts

Subject inserts for medals on this page are available in gold, silver, or bronze tone. \$2.50



#ES735
Honor Student



#ES746
Service



#ES698
Rifle



ES682
Fire Dept.



#ES762
Band



#ES743
Excellence



1st Place, gold
2nd Place, gold or silver
3rd Place, gold or bronze
4th Place, gold or bronze
5th Place, gold or bronze
6th Place, gold or bronze



#ES736
#ES738
#ES737
#ES739
#ES740
#ES741

 This symbol indicates Made in America

 This symbol indicates Made in America

A	ABU Digital Camo Tape	61	E	Edge Dressing	38	L	Laces	38	ROTC	
	ACU Digital Camo	57, 59, 95		EMS Flags	53		Lanyards	31	Collar Insignia	59
	Aiguillettes	28-29	F				Law Enforcement Explorer Award and Service Ribbons	Paradestore.com	Honor Insignia	56
	Air Force	65-67		Fire Department Flags	53, 65		Lead Banner Poles	90	Mini Rank Insignia	62
	Air Force Ceremonial Belt	35, 65		Fire Explorer, Junior Firefighter Award and Service Ribbons	Paradestore.com		Leader Loops	44	Medals	73, 75-78
	Air Force ROTC & JROTC	60-61		Fire / Rescue	50		Leather Polish and Color	38	Rank Insignia	59-60, 62
	Airline-approved Rifle Cases	15		Flag Accessories	84-91		Letter Openers	18	Ribbon Drapes	73-75
	APO/FPO	80-81		Flag Carriers	82-84				Ribbons	56, 61-62, 73
	Arc Pins	69		Flag Covers	3, 85	M	MarchOn® Tee Shirts	Paradestore.com	S	
	Armed Forces Berets	43		Flag Pole Floor Stands	86-87		MK1 Drill Rifles	8-9	Saber Accessories	19
	Armed Forces Flags	96-97		Flag Pole Ornaments	88-89		Medals	73-78	Sabers	16-17
	Army Ceremonial Belt	35		Flag Poles	90-91		Memorial	51-55	Sam Browne Belts and Accessories	36-37
	Army Enlisted Cap Insignia	64		Flag Protectors	85		Merchant Marine Flag	97	Scorpion (OCP) Custom Camo Name Tape	59
	Army National Guard Flag	97		Flags:			Mourning	51-55	Scorpion (OCP) Rank	59, 64
	Army ROTC & JROTC	56-59		Air National Guard Flag	97				Service Cap Carrier	66-67
	Ascots	44		Armed Forces	96	N			Shipping Charges	80-81
	Award Ribbon Ring	97		Casket	98		Nameplates	41	Shirt Garters	40
	Award Ribbons	56, 61-62, 72-75		Government Spec. U.S.	98		Navy JROTC Award Ribbons	62	Shoe & Boot Accessories	38-39
				Hand-held	51, 95		Navy JROTC Cap Devices	62	Shoe Polish	38-39
B				POW/MIA	Paradestore.com		Navy & Marines ROTC & JROTC	62	Shoes	39
	Band Insignia	63		States & Territories	94		NGA Rifle Stock and Kits	12	Shoulder Cords	23-31
	Bell Crown Firefighter Caps	50		U.S. — Bunting	95	O			Shoulder Patches and Tabs	56-57, 65, 95
	Belts	33-37, 64-65		U.S. — Indoor/Parade	99		OCP (Scorpion) Custom Camo Name Tape	59, 61	Spats and Leggings	38
	Berets	42-43		U.S. — Outdoor	98		OCP (Scorpion) Rank	59, 64	Special Forces Beret Flashes	42
	Bib Scarves • Leader Loops	44		World Nations	Paradestore.com		Old Guard Cheater Bars	39, 51	Stratton Hats	48
	Blousers	38		Flag Spreader	99		Ordering Information	80-81	Stratton Hat Straps	48
	Books	14		Floor Stand Adapters	86		Oxfords, High Gloss	39	Streamers	97
	Boots	39		Floor Stand Carrying Case	87				Sure-Grip Gloves	21, 100
	Buckle Bag	33	G						Sword Accessories	19
	Buckles	33, 35-36		Garment and Gear Bags	46-47				Sword Throgs	19
				Garters	40				Swords	16-17
C				Gloves	20-22, 100				T	
	Campaign Style Hat	48		Grave Markers	Paradestore.com				T.A.B.S.® Boot Blousers	38
	Canvas Flag Covers	3, 85		Guidon Poles	90				Tactical Boots	39
	Cap Carriers & Covers	48-49, 66-67		Guidon Floor Savers	90				Tassels and Cords	87
	Cap Cords and Straps	50, 66							Tee Shirts	32
	Cap Devices	58, 60-64, 66		H					Throgs for Sword Belt	19
	Cap Rain Covers	48		Hat Carriers	49, 66-67				Toggle and Extenders	41
	Caps	48, 50, 67		Hat / Collar / Lapel Pins	51, 58-69				Training Bar	14
	Casket Bands	52		Hat Cords	31, 50				Trooper Hats	48
	Challenge Coins	57, 61-62		Hat Trap	49				U	
	Cheater Bars	39, 51		Heel and Edge Color	38				Uniform Accessories	40
	Citation Frames	70		Heel Taps and Cheaters	39, 51				U.S. Air Force	65-67
	Civilian Guard Cheater Bars	39, 51		Helmets	45				Bandsman Cord	29
	Cleaning & Polishing	19, 38-39, 41		Honor Guard & Drill Manuals	14				Cap Straps	66
	Clothing	32		Honor Guard Breast Badges	65				Guidon (customizable)	65
	Clutch Backs	70		Honor Guard Horseshoe Heel Taps	39, 51				Honor Guard Ceremonial Belts	35, 65
	Code Alpha™ Garment & Gear Bags	46		Honor Guard Pin	51, 54, 68-69				Honor Guard Cap	67
	Collar Extender	41		I					Service Cap	67
	Color Compatibility Chart	30, 45		Insignia	56-66				Service Cords	29
	Color Guard Pins	68-69		Air Force	65-67				Silver Braid ¾"	66
	Commando Berets	42		Army	64				U.S. Army	64
	Cord Tips	28, 31		Band	63				U.S. Marine Corps	63
	Custom Award Streamers	97		Marines Corps	63				Belts & Buckles	35
	Custom Flags	58, 65, 92		ROTC & JROTC	56-62				V	
	Custom Patches	93		J					Veterans' Hat/Lapel Pins	68-69
	Custom Web Flag Carriers	83		JROTC Challenge Coin	57, 61-62				W	
D				JROTC Collar Insignia	59				Wally Garment Bags	47
	Damaged Goods	81		JROTC Honor Streamers	97				Whistles	41
	DrillAmerica® 1903 Springfield Replica Rifle	4-5, 13		JROTC Medals and Drapes	75-78				Wrist Wraps	22
	DrillAmerica® M1 Garand Rifle	6-7		JROTC, ROTC Ribbon Slides	56, 61-62, 72-73, 75					
	Drill America® MK1	8								
	Drill America® MK1 Masters Level	9								
	DrillAmerica® DA30 Parade Rifle	10								
	DrillAmerica® Rifles	4-10								
	DVD's	14								



12754 O'Connor Road
San Antonio, TX 78233

4 Easy Ways to Order!

1. Call Toll Free 800-653-5515
2. Fax Toll Free 800-555-9269
3. Mail this form to:

Glendale
12754 O'Connor Road
San Antonio, TX 78233

4. Order on-line:

www.ParadeStore.com
www.glendale.com

Customer # _____

Ordered By: _____

Position: _____

SHIP TO _____

School/Organization: _____

Street Address _____

Shipping Address: Home Business

City: _____ State: _____ Zip: _____

Phone: _____

Fax: _____

Date ordered: _____

Date items needed: _____

Rush? Any special shipping instructions? _____

(Additional charges for express delivery.)

Catalog Source Code: 23000

BILL TO

Name: _____

Address: _____

City: _____

State: _____ Zip: _____

Phone: _____

Fax: _____

E-mail address* _____

* Glendale may use my email address to notify me:

about orders and package tracking information;

about products, specials, and discounts.

Please add my e-mail address as a Bugler e-newsletter subscriber!

Quantity	Item #	Size	Color	Item Description	Unit Price	Amount
(min.50 per style)	Colors #1 _____ #2 _____ #3 _____ #4 _____ #5 _____ #6 _____ Refer to "Custom Patches and Flashes" on page 93 for specs and colors <input type="checkbox"/> A <input type="checkbox"/> B <input type="checkbox"/> C <input type="checkbox"/> D <input type="checkbox"/> E <input type="checkbox"/> F <input type="checkbox"/> G <input type="checkbox"/> H <input type="checkbox"/> I <input type="checkbox"/> J Check custom flash above Backing: <input type="checkbox"/> Iron on <input type="checkbox"/> Sew on				\$2.50	

Personalization (if applicable) to read:

Method of payment:

- Payment enclosed. Impac/GPC/SmartPay Visa
- Purchase order
- PO # _____ enclosed.
- Will pay for partial shipment/OK to backorder.

Credit Card # _____

_____/_____/_____ Security Code _____

Month / Year of Expiration

Signature _____

* CONTIGUOUS U.S. SHIPPING CHARGES		
\$ 0 - 15	add	\$6.50
\$ 16 - 25	add	\$8.00
\$ 26 - 50	add	\$12.00
\$ 51 - 75	add	\$14.50
\$ 76 - 100	add	\$17.00
\$ 101 - 200	add	\$23.00
\$ 201 - 300	add	\$29.00
\$ 301 - 400	add	\$33.00
\$ 401 - 599	add	\$36.00

Shipping to APO/FPO and US addresses not within the contiguous U.S.:

Under \$600: amount on the contiguous U.S. Shipping Chart, plus \$10.

Over \$600: 8% of the merchandise value, plus \$10 (All shipping charges outside of the contiguous U.S. are estimated. Please contact a Glendale service representative to verified shipping charges.)

Estimated Shipping to non-US addresses:

Amount on the contiguous U.S. Shipping Chart, plus an additional 20% of merchandise value, plus \$10. If estimate is not sufficient, we will notify you prior to shipping. There are product and size limitations for shipping to some foreign countries. Please verify your nation's current import restrictions. Glendale and ParadeStore.com are not responsible for import regulations or collection or payment of duty, tax or brokerage fees at non-U.S. addresses.

There will be an additional charge for Express Air Service, determined by weight.

Merchandise Value	
Add Sales Tax for your state.	
FREE SHIPPING for orders over \$600 UPS ground shipping within the contiguous U.S. <i>** (Must add additional shipping surcharges if applicable)</i>	FREE** if your order is over \$600!
* Shipping Charges for orders under \$600 of Merchandise Value	
**Additional shipping surcharges, if applicable, on facing page	
Total	

Call between 8:00AM and 5PM CST and you will always reach a customer service representative. No answering machine or phone tree!

Glendale Makes Ordering Easy

- By Phone: 800-653-5515 or 201-767-0233
Mon-Fri 8 AM - 5 PM Central Time
 - By Fax: 800-555-9269 or 201-767-3323
7 days a week, 24 hours a day.
 - Online: www.ParadeStore.com (Also a great way to learn more about us, subscribe to the "Bugler" newsletter or send us an e-mail.
 - By Mail: 12754 O'Connor Road San Antonio, TX 78233.
- (If a mailed order confirms a phone, fax, e-mail, or Web order, please mark it "CONFIRMATION" to avoid duplication.) Within TX, add 8.25% sales tax. If tax-exempt, notification must be included at time of order. Please make a note of your customer account number that appears above your name on the address label. Using it for each order or inquiry speeds response time! Order Processing: Most orders are processed and available items are shipped within 5 business days. (Refer to the UPS Ground Service map for time in transit.)

Back Orders:

Unforeseen demand or manufacturer's delays occasionally result in items that are out of stock. Nevertheless, it is our policy to ship all available merchandise and back order the balance unless customer specifies otherwise. There are no additional delivery charges for multiple shipments within the contiguous U.S.

Custom Orders: Please plan accordingly. Custom work may take 4 - 10 weeks for delivery. Submit specifications for custom work, including imprinting, embroidery and engraving in writing. Credit cards will be charged and items cannot be canceled once production has begun.

Prices:

Prices in this catalog are FOB San Antonio, TX effective August 1, 2023, and supersede all previously published prices. **We reserve the right to correct and change prices due to errors or frequent manufacturer increases.**

Payment Terms: Credit will be extended on authorized purchase orders of U.S. schools, military, police and fire units, and government agencies. Terms are Net 30 days. Visa, MasterCard, Discover, American Express and Impac/GPC/Smart Pay Visa orders are accepted. All other orders prior to shipment must be paid in full by check or money order to Glendale. Orders with declined credit cards will be canceled and are subject to a \$5 charge on reorders. When authorized, we will make partial shipments to meet customer deadlines; but partial invoices must be paid within our payment terms.

Colors:

We try to accurately reproduce all colors shown in this catalog, but some variation may occur due to the printing process. Reorders are best handled by sending a sample for us to match colors. We aim for consistency, but variation in dye lots may occur. Small fabric swatches are available for cords, berets and bib scarves.

Shortages or Damaged Goods:

Despite our quality assurance efforts, damages can occur in production or transit and order processing errors can be made. Please inspect all merchandise carefully. Call Customer Service at 1-800-653-5515 to report damages and claims. If a shipment is damaged in transit, it may be necessary for the carrier to inspect the shipment. Hold all cartons and packaging materials until you speak to us. We cannot accept responsibility for shortages or damages reported more than 48 hours after delivery.

Glendale Exclusives:

Glendale has created and developed many unique and exclusive items. We are the only source for these products and reserve the right not to sell them for resale. Retail sales only.

Suggestions:

We appreciate any suggestions, comments, criticisms, or questions you may have about our catalog, website, products, or service.

Guarantee:

We fully guarantee all merchandise against defects in material and workmanship.

Returns and Exchanges:

If there are any problems, please notify us immediately upon receipt of order. Merchandise must be returned only with prior authorization within 30 days of receipt in "as shipped" condition, including all original and retail packaging. We cannot accept returns of rifles, two-color cords, three-color cords, personalized items, DVDs or CDs, books, medals with inserts, custom orders or used or altered merchandise. A 15% restocking charge will apply to all Sabers & Swords as well as Sam Browne belts and straps.

Return items to: Glendale, Attn: Returns, 12754 O'Connor Road San Antonio, TX 78233.

- We will refund the purchase price for returned items.
- Original shipping charges are not refundable nor can they be credited unless shipment is Glendale's error. Only then will we pay return and/or replacement shipping charges.

Shipping Information:

All packages will ship UPS Ground or US Postal Service (USPS), whichever is more expedient. APO/FPO will be sent USPS Priority, and a receiver's signature will be required. UPS fees incurred for change-of-delivery address or address errors after package has shipped will be charged to customers.

Please Note:

For UPS Ground delivery, include a street address in shipping instructions. For all orders shipped by ground service within the contiguous United States, shipping charges are determined by the MERCHANDISE VALUE + any additional shipping surcharges for flag pole floor stands, rifle cases and drill bars.

ADDITIONAL SHIPPING SURCHARGES

For Flagpoles, Floor Stands, Weighted Training Bars and Rifle Cases, add the following weight surcharges to regular shipping fees.

Flag Pole Floor Stands

AAA \$10 each	L8 \$7 each	LG20 \$15 each
AMG \$10 each	L15 \$10 each	MFS \$15 each
C \$8 each	L20 \$15 each	MFS1 \$15 each
EN \$6 each	LG8 \$7 each	3W \$20 each
F \$7 each	LG15 \$10 each	

Weighted Training Bar

DRILLBAR8: \$7 each if shipped in the lower continental US*

Rifle Cases

23, 24: \$7 each if shipped in the lower continental US*

Flag Carrying Cases

61, 65: \$10 each if shipped in the lower continental US*

Hat Carriers

512, 513, 516, 29: \$7 each if shipped in the lower continental US*

Gun Rack

GUNRACK-22: \$35 each if shipped in the lower continental US*

Flagpoles and Guidon Poles

\$5 each if shipped in the lower continental US*

* The lower continental US consists of all the states except AK and HI. Higher surcharges apply if shipped outside the lower continental US depending on region- Call for Quote

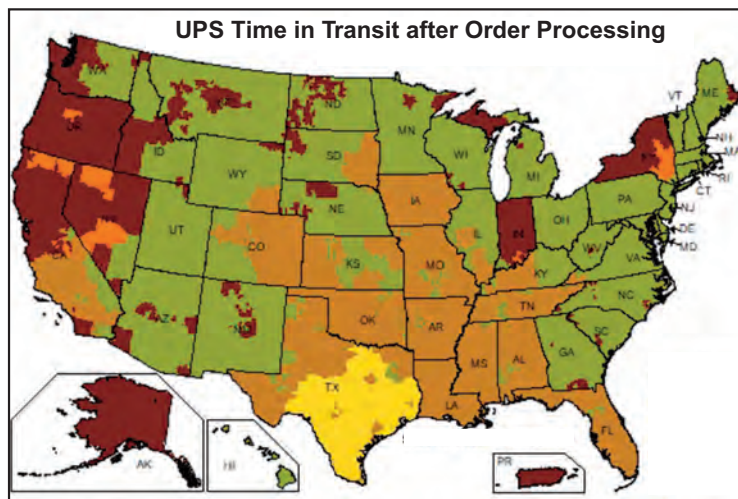

1 day 2 days 3 days 4 days 5 days 6 days

Most orders are processed and available items are shipped within 5 business days. For delivery estimate, add the UPS ground transit time from TX to your location shown on this UPS map.

Glendale assumes no liability for any loss, damage, injury, or expense of any kind arising out of the use or abuse of products in this catalog. This catalog may not be reproduced in whole or in part without the written consent of Glendale.

Copyright © 2024 Glendale Parade Store, LLC.



US Capital Police Honor Guard



Black Clarino with nickel, #897BKC

glendale
exclusive



Flag Cup Insert, Leather



This black leather insert fits inside the metal flag cups of all Glendale flag carriers to hold any 1" diameter pole more securely. Will not be visible in any of the polished cups. 1 3/4" H.

Leather Flag Cup Insert #2281 **\$8.95** each

Honor Guard Leather Flag Carriers



The standard of quality. This double harness is made from skillfully stitched top quality leather with premium polished metal flag cups to serve proudly for years to come. Double adjustable 1 3/4" straps. Hole at bottom of cup accommodates guidon pole.

Black with brass	#896BK	\$247.95 each
Extra Large Black with brass	#896BKXL	\$262.95 each
Black with nickel	#897BK	\$239.95 each
Extra Large Black with nickel	#897BKXL	\$254.95 each
Black Clarino with brass	#896BKC	\$259.95 each
Black Clarino with nickel	#897BKC	\$249.95 each
White with brass	#896WH	\$281.95 each
White with nickel	#897WH	\$269.95 each



Mounted Guard Leather Flag Carriers



Reinforced black leather Flag Carrier for mounted color guard. 10" high to securely hold a flag pole while riding. Two buckles and two 1/2" straps allow adjustment on a stirrup.

Brass buckles #1705 **\$52.95** each
Nickel buckles #1706 **\$52.95** each

How to clean Clarino
Clarino is a synthetic leather known for its durability and high-gloss finish. To keep Clarino clean and supple, use a spray-on furniture polish. Lightly spray the polish onto a soft cloth, apply to the belt or flag carrier, then buff dry. (You can also use a furniture polish wipe to attain similar results.)



Belt Mount Flag Carrier #132BK



Slide-on Flag Carrier #131BK



Leather Flag Carrier with Belt #130BK

Leather Flag Carriers with Belt



Leather waist carrier with reinforced leather shield and heavy plastic flag cup. Nickel buckle. 1 3/4" belt. Please state waist size up to 44". (Larger sizes available. Please call for prices.)

Black #130BK	\$59.95 each
White #130WH	\$75.95 each

Belt Mount Flag Carriers



This slides over any belt up to 2 1/4" wide to seat flag securely at waist level. Leather shield. Heavy plastic flag cup.

Black #132BK	\$42.50 each
White #132WH	\$50.50 each
Black Clarino #132BKC	\$71.75 each

Slide-on Flag Carriers



Two loops slip over belts up to 2 1/4" wide. Reinforced leather shield. Heavy plastic flag cup.

Black #131BK	\$42.50 each
White #131WH	\$50.50 each
Black Clarino #131BKC	\$71.75 each



Double Harness, front view #1902



Double Harness, back view #1902



Single Harness, white, #1901

Web Single Harness Flag Carriers

Single harness with 2" webbing, reinforced leather shield, adjustable strap, heavy plastic flag cup and vinyl buckle.

- White webbing, flag cup, and buckle #1901 **\$39.95** each
- Same as above with an added 5" #1901XL **\$51.50** each
- Black webbing, flag cup, and buckle #1903 **\$39.95** each
- Same as above with an added 5" #1903XL **\$51.50** each

Web Double Harness Flag Carriers

Double harness with 2" webbing, reinforced leather shield, adjustable straps, heavy plastic flag cup and vinyl buckle.

- White webbing, flag cup, and buckle #1902 **\$55.25** each
- Same as above with an added 5" #1902XL **\$65.25** each
- Black webbing, flag cup, and buckle #1904 **\$55.25** each
- Same as above with an added 5" #1904XL **\$65.25** each

Custom Web Flag Carriers

Substitute a polished metal flag cup (as shown below) to any #1901 or #1902 flag carrier.



Nickel flag cup, # 1902PN



Brass flag cup, #1902PB

Custom Single Web Flag Carriers

- White with polished brass cup #1901PB **\$129.95** each
- White with polished brass cup, XL #1901PBXL **\$139.95** each
- White with polished nickel cup #1901PN **\$119.95** each
- White with polished nickel cup, XL #1901PNXL **\$129.95** each
- Black with polished brass cup #1903PB **\$129.95** each
- Black with polished brass cup, XL #1903PBXL **\$139.95** each
- Black with polished nickel cup #1903PN **\$117.95** each
- Black with polished nickel cup, XL #1903PNXL **\$127.95** each

Custom Double Web Flag Carriers

- White with polished brass cup #1902PB **\$139.95** each
- White with polished brass cup, XL #1902PBXL **\$149.95** each
- White with polished nickel cup #1902PN **\$129.95** each
- White with polished nickel cup, XL #1902PNXL **\$139.95** each
- Black with polished brass cup #1904PB **\$139.95** each
- Black with polished brass cup, XL #1904PBXL **\$149.95** each
- Black with polished nickel cup #1904PN **\$129.95** each
- Black with polished nickel cup, XL #1904PNXL **\$139.95** each



White Double Harness with Brass Flag Cup, #900WH

Best Quality Web Double Harness Flag Carriers — with Guidon Pole Cup

Double harness with 2" heavyweight pistol belt webbing and double adjustable shoulder straps. Reinforced leather shield and polished brass or nickel flag cup. Hole at bottom of cup accommodates guidon pole.

- Black/Brass #900BK **\$149.95** each
- Black/Nickel #899BK **\$139.95** each
- AF Blue/Brass #900AFB **\$149.95** each
- AF Blue/Nickel #899AFB **\$139.95** each
- White/Brass #900WH **\$149.95** each
- White/Nickel #899WH **\$139.95** each
- OD/Brass #900OD **\$149.95** each
- OD/Nickel #899OD **\$139.95** each



AF Blue Double Harness with Nickel Flag Cup, #899AFB



Black Harness with Brass Flag Cup, #900BK



Olive Drab All-Web Carrier #891OD

Call us at **800-653-5515** for fit questions and sizing information.

Guidon Flag Carriers

What makes this Guidon Carrier unique is its leather flag cup, narrowed to hold a guidon pole, with a hole at the bottom to allow for the ferrule to pass through as shown. Harness has 2" white webbing, adjustable strap, reinforced leather shield and white vinyl buckles.

- Single #1701 **\$46.75** each
- Double #1702 **\$61.75** each

“I've never had a problem with any order! Thank you..”
K.R., MI



Single Guidon Flag Carrier, #1701

All-Web Flag Carriers

Web flag carriers with web cups. Adjustable straps that cross at the back similar to the Double Harness #1902 photo at the top of the page.

- White #891WH **\$69.95** each
- Black #891BK **\$69.95** each
- Navy #891NV **\$69.95** each
- Olive Drab #891OD **\$69.95** each



Single Harness Leather Flag Carriers 

A well made leather carrier at an attractive price. 1 1/4"-wide leather single harness with leather shield, reinforced adjustable straps, heavy plastic flag cup and nickel buckle.

Black	#1801BK	\$49.95 each
White	#1801WH	\$59.95 each
Black Clarino	#1801BKC	\$93.75 each



Double Harness Leather Flag Carriers 

Comfortable, sturdy, all-leather harness with large shield, adjustable straps, heavy plastic flag cup and nickel buckles. 1 1/4" W.

Black	#1802BK	\$56.95 each
Black: +5"	#1802BKXL	\$69.95 each
Same as above, in Black Clarino or White.		
Black Clarino	#1802BKC	\$108.95 each
Black Clarino: +5"	#1802BKCXL	\$119.95 each
White	#1802WH	\$69.95 each
White: +5"	#1802WHXL	\$88.75 each

The 1802 flag carrier can be special-ordered in smaller sizes. Send measurements required. (For instance, 12" less on the long straps and 4" less on the short straps.)

Black	#1802BKXS	\$67.95 each
White	#1802WHXS	\$76.75 each



Call us at
800-653-5515
for fit questions
and sizing
information.

Back view of Double
Leather Flag Carrier in
white
#1802WH



Pole Insert

Avoid frustration and demerits. This simple tapered insert makes guiding the flag pole into the cup a smooth and easy endeavor. The permanent, press fit attachment is made of cold rolled steel for durability. #2217 works with our line of 1 1/8" diameter Perfect-Fit Parade Poles, #2217S works with 1" Perfect-Fit Parade Poles. (See page 91). 4" long with taper starting 2.5" from the end.

Pole insert	#2217	\$24.95 each
Pole insert	#2217S	\$22.25 each

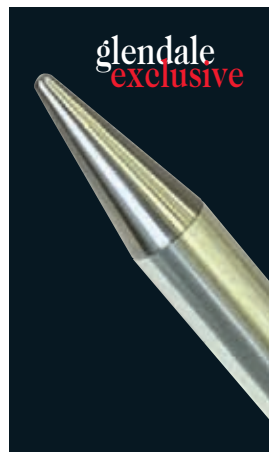

All of Our Flag Carriers Are Proudly Made in the U.S.A

Add a Polished Metal Cup to a Single or Double Harness Leather Flag Carriers

Substitute a polished metal flag cup to any Single Harness (#1801) or Double Harness (#1802) Leather Flag Carrier. Also available in Nickel (not shown).



Single Leather Flag Carriers with Polished Metal Cup

Black with polished brass cup	#1801BKPB	\$131.75 each
Black with polished nickel cup	#1801BKPN	\$124.95 each
Black Clarino with polished brass cup	#1801BKCPB	\$164.95 each
Black Clarino with polished nickel cup	#1801BKCPN	\$145.75 each
White with polished brass cup	#1801WHPB	\$144.95 each
White with polished nickel cup	#1801WHPN	\$134.95 each

Double Leather Flag Carriers with Polished Metal Cup

Black with polished brass cup	#1802BKPB	\$139.95 each
Black with polished brass cup, XL: +5"	#1802BKPBXL	\$149.95 each
Black with polished nickel cup	#1802BKPN	\$129.95 each
Black with polished nickel cup, XL: +5"	#1802BKPNXL	\$139.95 each
Black Clarino with polished brass cup	#1802BKCPB	\$174.95 each
Black Clarino with polished brass cup, XL: +5"	#1802BKCPBXL	\$188.75 each
Black Clarino with polished nickel cup	#1802BKCPN	\$169.95 each
Black Clarino with polished nickel cup, XL: +5"	#1802BKCPNXL	\$179.95 each
White with polished brass cup	#1802WHPB	\$149.95 each
White with polished brass cup, XL: +5"	#1802WHPBXL	\$159.95 each
White with polished nickel cup	#1802WHPN	\$139.95 each
White with polished nickel cup, XL: +5"	#1802WHPNXL	\$149.95 each



Airliner Flag Carrying Case

Designed for frequent travel, this rugged case is called the "Airliner" for a reason! The innovative three-piece telescoping design extends from 48" to 88" and has a diameter of 5 1/2" to accommodate a mounted flag. This tough molded tube is lockable for secure travel and has a comfortable molded handle for easy carrying. Because it nests to only 48", it can easily be shipped by US Mail to overseas customers. Airline approved!



#65 **\$89.95** each (*\$10)

* There is a shipping surcharge for heavy items. The surcharge is in parentheses following the price. See page 81 for complete shipping information.

Flag Carrying Case

The perfect case for carrying or storing two poles up to 8 1/2" long or one mounted flag set with spear ornament. 4 1/4"-diameter tube telescopes from 60" - 102" and has protective foam padding at the top. Easy-to-load hinged door with padlock eyes. Please note: This case is oversized and can only be shipped by UPS Ground or Parcel Select.

#61 **\$94.95** each (*\$10)

Display Pole Case #49

Display Pole Carrying Case with Handle

Holds any two-piece pole, up to 8 feet, except 94TG & 98TGE telescoping poles. Multiple interior pockets for accessories and ornaments. Handle carrying strap. Made from heavy, water-resistant woven nylon material. Full perimeter length zipper makes it easy to load. 8 1/4" x 60". Black.

Display Pole Case #49 **\$49.50** each

Parade Case #67

Parade Flag Pole Carrying Case

This heavyweight vinyl case has snap closures, a shoulder strap and handle. At 10" x 59", it will hold any two-piece Glendale parade pole, including the 8' pole, except 94TG and 98TGE telescoping poles. Internal compartment separates the pole halves for added protection. This case will fit a mounted flag and a 7" eagle ornament.

Parade Case #67 **\$69.50** each

Canvas Flag Covers



These durable water-resistant flag covers are sized to fit over any fully-mounted assembled pole with a spear ornament and 3' x 5' flag. Designed by Glendale for parade and competition use and made exclusively for us. The 8" x 56" - 58" cover has a pierce-resistant spear compartment at the top and a slip-cord and lock closure at the bottom. We can personalize these covers (see below). Canvas cover weighs 9 oz.

Navy, royal, black, red, dark green.
Canvas Flag Cover #68 **\$37.95** each

Flag covers will protect flags from weather conditions and minimize damage while traveling to and from parade and display sites.



glendale
exclusive

"Thank you. I really appreciate the effort that you've made on our behalf. This is exactly why I recommend you all to those I work with."

Paul

Dust Cover

Protects mounted flag sets while on display. Clear, heavy-gauge polyethylene. 12" x 108". (not shown)

Dust Cover #60 **\$7.50** each



Rain Cover #59

Rain Cover

Carry or store a mounted flag set. Durable and waterproof, soft tan vinyl, lined with protective material. Tie tape closure. 8" x 70". Color: Tan.

Rain Cover #59 **\$30.25** each

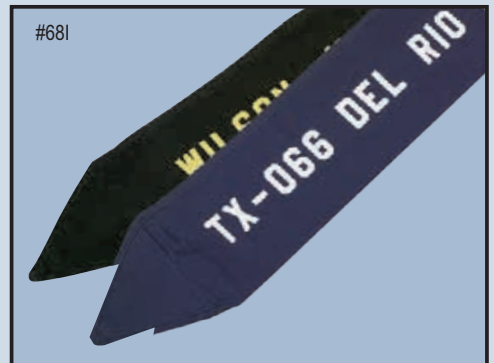

#68I



Nylon Flag Cover #48

glendale
exclusive

Nylon Flag Cover

This 8" x 56" cover has a pierce-resistant spear compartment at the top and a slip cord and lock closure at the bottom. Wt. 6 oz. Color: Black.

Nylon Flag Cover #48 **\$35.95** each

Imprinted Canvas Flag Covers

Letters available in 2", upper case only. All orders for imprinting must be submitted in writing to avoid misprints. Email us at customerservice@glendale.com. Cover will be printed horizontally (as shown) with up to 25 characters/spaces. If a vertical design is needed, only 20 spaces are available. No punctuation marks.

Step One—choose cover color :

Navy - #68NV, Red - #68RD, Royal - #68RY, Black - #68BK, Green - #68GR

Step Two—choose direction of printing:

Horizontal - HI, Vertical - VI

Step Three—choose the color for the lettering:

White - WH, Gold - GO, Red - RD, Black - BK

Step Four—choose the number of letters

A: 1-6 (vertical or horizontal) **\$45.95** each

B: 7-13 (vertical or horizontal) **\$49.25** each

C: 14-25 (Horizontal only) **\$63.25** each

Step Five—put it all together. The code for a navy flag cover, with horizontal printing, white lettering, and 15 letters would be #68NV HI WH C.

Call if you need assistance, we're happy to help. 1-800-653-5515

Show off your colors!

Note: Guidon poles with pointed bottom ferrules will only fit in MFS & PFS stands. To use Guidon poles with other Glendale stands, order our exclusive Floor Stand Adapters see below.



Original Military Floor Stand #MFS



Single Military Floor Stand (without adapter) #MFS1



Commodore Stand #C

Commodore® Floor Stands

The Commodore stand is made of durable ABS plastic with a rich, permanent matte gilt finish. Includes an adapter sleeve to allow use with a 1-1/4" diameter pole. Base measures 11 1/2".



10 lbs. (Weighted with sand)	#C	\$52.95 each (\$8*)
2 lbs. (Not weighted)	#CE	\$49.95 each

Military Floor Stands

As beautiful as they are functional. These highly polished, reflective chrome stands will accommodate any pole up to 1 1/4" diameter, as well as the bottom ferrule of any military guidon staff. Tip-resistant flat base has a diameter of 13" and weighs 30 pounds without adapter. Two styles: Original (includes adapter that accommodates one, two or three guidon staffs or 1" poles). Single (holds one flag with pole up to 1 1/4" diameter). Shaft height of both styles is 11 1/2".



Original Military Floor Stand (with adapter)	#MFS	\$579.00 each (\$15*)
Single Military Floor Stand (without adapter)	#MFS1	\$459.00 each (\$15*)
MFS Carrying Case, holds up to 30 lbs.	#35MFS	\$46.95 each

Admiral® Floor Stands

Extremely stable 18-pound cast iron stand with gold aluminum anodized matte cover (similar in appearance to Commodore Floor Stand). Includes an adapter sleeve that allows use with a 1" diameter pole. Base measures 11 1/2". (Not shown.)

For a 1-1/4" pole	#AMG	\$179.95 each (\$10*)
For a 1/4 - 1 3/8" pole	#AAA	\$169.95 each (\$10*)



Three-Way Stand #3W

Three-Way® Floor Stand

Create a dramatic display with this versatile stand designed to accommodate one, two, or three 1-1/4" diameter poles. Cast iron 12" base with gold aluminum cover.

Three-Way Stand (45 lbs.)
#3W **\$379.00** each (\$20*)

Makes Guidon Poles fit regular floor stands!

Floor Stand Adapters

A simple and inexpensive solution to the problem of how to use a guidon pole with a regular flag pole floor stand. Just place the 12" adapter into the stand, then slide the pole into the adapter. The pole will be held upright and securely. Available with brass or chrome finish to match the metal on the guidon poles and/or similarly finished floor stands.

Brass finish	#1101	\$25.95 each
Chrome finish	#1102	\$25.95 each

glendale
exclusive

Chrome adapter #1102

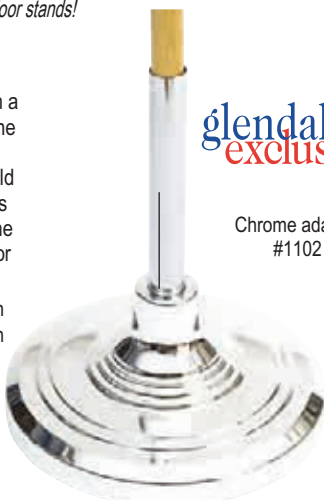

Brass adapter #1101



Ensign Stand #EN

Ensign® Floor Stand

An attractive, economical stand designed for smaller flags and pole sets that require less weight and base size. Made of tough ABS plastic with a matte gilt finish. Includes an adapter sleeve to allow use with a pole of 3/4-1" diameter. Base measures 9 1/2".

5 lbs. (Weighted with sand)
#EN **\$44.95** each (\$6*)

QUANTITIES ARE LIMITED!



Portable Floor Stand #PFS

Portable Floor Stand

This is made of a strong, durable polymer plastic in a dark brown finish. When completely folded, the stand measures 24" x 2 1/8". Weight: 2 lbs. An adaptor sleeve is included to accommodate various pole diameters. Because of the open bottom, this stand will hold a guidon pole with tapered metal ferrule attached. Light weight use, not intended for windy outdoor use.

Portable Floor Stand #PFS **\$33.95** each



Liberty® Floor Stands

Made of strong ABS plastic with a bright metalized finish. Includes an adapter sleeve to allow use with a pole of 1-1/4" diameter. The base of each stand measures 11 1/2". (The 2-lb. stand is not weighted; the 8-lb. stands are weighted with sand; 15- and 20-lb. stands, with sand and Dura-steel shot.)

- Chrome 2 lbs. #LE \$57.95 each
- Chrome 8 lbs. #L8 \$59.95 each (\$7*)
- Chrome 15 lbs. #L15 \$79.95 each (\$10*)
- Chrome 20 lbs. #L20 \$97.95 each (\$15*)
- Gold 2 lbs. #LGE \$57.95 each
- Gold 8 lbs. #LG8 \$59.95 each (\$7*)
- Gold 15 lbs. #LG15 \$79.95 each (\$10*)
- Gold 20 lbs. #LG20 \$97.95 each (\$15*)



Liberty Stand
Chrome
#L8

Our Best Seller!
Liberty Stand
Gold
#LG8



Freedom Stand
#F

Freedom® Floor Stands

Made of strong ABS plastic with a gilt matte finish. Includes an adapter sleeve to allow use with a pole of 1-1/4" diameter. The base of each stand measures 11 1/2".

- 8 lbs. (Weighted with sand) #F \$52.95 each (\$7*)
- 2 lbs. (Not weighted) #FE \$49.95 each



glendale
exclusive

Carrying
Case
#35

Floor Stand Carrying Case

Protect your stand while making transport easier. Made of a weather-resistant black nylon with a reinforced carrying handle and heavy duty zipper. Strong vinyl bottom. Suitable for any Glendale flag stand weighing. MFS case comes with 2" X 12" draw string bag to house chrome sleeve or adapter.

Carrying Case holds up to 25 pounds. Base measures 12" across. #35 \$39.95 each

MFS Carrying Case holds up to 30 pounds. Base measures 13" across. #35MFS \$46.95 each

* Due to increased shipping charges for the heavyweight stands, there is a shipping surcharge for all weighted floor stands (those over 2 lbs.). The surcharge is shown in parentheses following the prices of items requiring the additional shipping fee.



Save when you buy a Mounted Flag Set. Turn to page 99 for more information.

Make Your Flag a Statement

Tassels and Cords

- GOLD**
- 3" Tassels with 5' Cord for 2' x 3' flag #117 \$24.95 each
 - 5" Tassels with 9' Cord for 3' x 5' flag #118 \$29.95 each
 - 6" Tassels with 9' Cord for 4' x 6' flag #119 \$31.95 each
- SILVER**
- 4 1/2" Tassels with 9' Cord for 3' x 5' flag #124SV \$34.95 each
- WHITE**
- 6" Tassels with 9' Cord for 4' x 6' flag #124WH \$39.95 each
- Red White and Blue**
- 7" Tassels with 9' Cord for 3' x 5' flag #124RWB \$122.95 each



Email customerservice@glendale.com • Order online at www.glendale.com

Perfect Fit Ornaments

Perfect-Fit Ornaments  Threaded to fit precisely atop our Perfect Fit Aluminum Flag Poles (see page 91), our brass Perfect-Fit metal ornaments are also compatible with all of our Two-Piece Polished Wood Flag Poles (see page 90) except 24GE and 24SE.

Army Spear

The appropriate ornament for Army and Marine Corps flags is the gold Army spear; for the Air Force flag, the silver Army spear. For Perfect-Fit poles only.

- Gold, 8" 22GE **\$69.95** each
- Silver, 8" 22SE **\$69.95** each

For Perfect Fit poles and wood poles.

- Gold, 8" 24GE **\$84.75** each
- Silver, 8" 24SE **\$84.75** each

Eagle Ornament

Our country's symbol soars in bright metal. 7" tall with 7" wingspan.

- Gold, 7" 7GE **\$54.95** each

Flat Spear

- Gold metal, 7 1/2" 32GE **\$59.95** each
- Silver metal, 7 1/2" 32SE **\$59.95** each

3" Parade Balls

- Gold #87BE **\$54.95** each
- Silver #87CE **\$54.95** each

Star of David

- Gold metal, 6 3/4" 34GE **\$64.95** each

Passion Cross

- Hammered Surface, 6 1/2" #26GE **\$54.95** each



Army Spear, Silver, 8" #22SE

Army Spear, Gold 8" #22GE

Eagle, Gold 7" #7GE

Army Spear, Silver, 8" #24SE

Army Spear, Gold 8" #24GE



Flat Spear, Silver 7 1/2" #32SE



Flat Spear, Gold 7 1/2" #32GE



3" Parade Ball, Silver #87CE



3" Parade Ball, Gold #87BE



Star of David 6 3/4" #34GE



Passion Cross, Brass 6 1/2" #26GE

Don't see the Perfect-Fit ornament you want? No problem!

Traditional-Fit to Perfect Adaptor
Our solid brass adaptor lets you install Traditional Fit ornaments (page 89) onto any Perfect Fit Pole.

2222E Perfect Fit Adapter **\$20.75** each



Perfect-Fit Ornaments

Are threaded to fit precisely atop our Perfect-Fit Aluminum Parade Poles, each Perfect-Fit ornament is also compatible with all of our Two-Piece Polished Wood Flag Poles. (See pages page 90 Perfect-Fit to Traditional-Fit adaptor. See page 91.

Traditional-Fit Ornaments

Are made to slip over the top of poles. They are compatible with our Traditional Fit Aluminum Parade Poles and all of our Two-Piece Polished Wood Flag Poles. (See pages 90-91.) (Please note a fibroid sleeve #2228 is necessary for a tighter fit with the aluminum poles)

Flag Pole Accessories

Flag Accessories

- NEW!** Tangle-free Flag Mounting Swivels with carabiner for 1"-1.25" diameter poles
- Black, set of 2 #2276B **\$19.95** set
- Aluminium set of 2 #2276A **\$18.95** set
- 5" Tapered Bottom Ferrules. For 1" wood poles only. (To fit, it will be necessary to undercut the pole.) Available with Brass or Chrome finish.
- Brass #2218 **\$69.95** each
- Chrome #2219 **\$74.95** each
- Nylon Snap Hook for second flag on halyard. #2210 **\$3.50** each
- Pole screw joint, brass, 1" diameter. #2204 **\$34.95** each
- Pole screw joint, brass, 1 1/4" diameter. #2205 **\$34.95** each
- Pole screw joint, brass, 1 3/8" diameter. #2206 **\$49.95** each
- Ornament Ferrule, 2" x 1" for #5A, #7A, #11A and #31G ornaments. #2207 **\$12.95** each
- Black Plastic Sleeve Insert for Commodore, Liberty or Freedom Floor Stands. #2209 **\$3.95** each
- Adjustable aluminum ring with screw eye, 1". #2220 **\$6.50** each
- Adjustable aluminum ring with screw eye, 1 1/4". #2221 **\$9.95** each
- Perfect Fit Adapter #2222E **\$22.95** each
- Rubber stopper for bottom of 1" aluminum pole. #2223 **\$1.95** each (Items # 2222 and 2223 not for use on telescoping or wood-grained steel poles.)
- Rubber stopper for bottom of 1 1/4" aluminum pole. (Not for use on telescoping pole.) #2224 **\$2.50** each
- E-Z Mount plastic flag rings to attach a flag with grommets to an indoor pole. 1" pole #2277 **\$1.95** each
- 1 1/4"-1 3/8" pole #2278 **\$4.95** each
- Nylon flag ties. #2226 **\$.95** each

Easy to add Tangle-free Mounting Swivels prevent flags from wrapping around poles. Fit poles up to 1 1/4" dia.



Tangle-free Flag Mounting SwivelsBlack #2276B



Aluminium #2276A



Pole Screw Joint #2204

Black Plastic Sleeve Insert for Commodore, Liberty or Freedom Floor Stands.



#2209



Adjustable Ring #2220

Perfect Fit Adapter



#2222E



#2277

#2278



Tapered Bottom Ferrule #2218

Brass Ornaments

T **Solid Brass Ornaments**
 Fit High quality and built to last for years. Will fit our Traditional Fit Aluminum Pole all of our Two-Piece Polished Wood Flag Poles (see page 90).

Army Spears

The appropriate ornament for Army and Marine Corps flags is the gold Army spear; for the Air Force flag, the silver Army spear.

Brass, 7"	#22B	\$64.95	each
Brass, 8 1/4"	#22LB	\$79.95	each
Chrome, 7"	#22C	\$74.95	each
Chrome, 8 1/4"	#22LC	\$89.95	each



Army Spear, Brass 7" #22B
 Army Spear, Chrome 7" #22C



Plain Church Cross, 9 1/4" #56
 Guiding Star 7" #27
 Eastern Star 7 1/4" #27A

Round Spears

Brass, 8"	#85G	\$59.95	each
Chrome, 8"	#85C	\$69.95	each



Round Spear, Brass 8" #85G
 Round Spear Chrome, 8" #85C
 Fancy Spear, Brass 8" #31G

Spears and Lances

Fancy Spear Brass, 8"	#31G	\$59.95	each
Battalion Lance Brass, 9 1/2"	#13B	\$69.95	each



Botonee Cross, Brass 7 3/4" #83B
 Battalion Lance 9 1/2" #13B
 Maple Leaf: brass, 8 1/4" #10A

Brass Cross

Plain Church Cross brass, 9 1/4"	#56	\$79.95	each
Botonee Cross brass, 7 3/4"	#83B	\$109.95	each

Stars

Guiding Star, brass, 7"	#27	\$59.95	each
Eastern Star, brass, 7 1/4"	#27A	\$59.95	each

Maple Leaf

Brass, 8 1/4"	#10A	\$99.95	each
---------------	------	---------	------

High Impact Styrene Ornaments

T **Styrene Ornaments**
 Fit The look of metal but at significant savings. Will fit our Traditional Fit Aluminum Pole all of our Two-Piece Polished Wood Flag Poles (see page 90).

Round Styrene Spears

Round Gold styrene, 8 1/4"	#85SG	\$27.95	each
Round Silver styrene, 8 1/4"	#85SC	\$27.95	each

Fancy Styrene Spears

Fancy Gold styrene, 7 3/4"	#31SG	\$27.95	each
----------------------------	-------	---------	------

Classic Eagle Styrene Ornament

Perched eagle made of high-impact styrene plastic with bright silver or gold finish. Has removable ferrule and includes adapter for use with 1 1/4" poles. 8 1/2" wing span.

#6SC	Silver	\$29.95	each
#6SG	Gold	\$29.95	each

Perched Eagle Styrene Ornament

Lightweight and extremely durable. Made of high-impact styrene plastic with an antique gold-plated finish. 7" wing-span

#7S	\$29.95	each
-----	---------	------



Round Styrene Spear, Gold 8 1/4" #85SG
 Round Styrene Spear, Silver 8 1/4" #85SC
 Fancy Styrene Spear, Gold 7 3/4" #31SG

Classic Styrene Eagle, Silver 8 1/2" #6SC
 Adapter included!

Perched Styrene Eagle, Gold 7" #7S

Brass Plated Aluminum Ornaments

T **Brass Plated Aluminum Ornaments**
 Fit Sturdy yet light weight, with brass plating that looks sharp and wears well. Will fit our Traditional Fit Aluminum Pole all of our Two-Piece Polished Wood Flag Poles (see pages 90-91).

Gold Eagle Flag Pole Ornaments

Perched eagles in bright, brass-plated aluminum casting. Sizes are based on wing spread.

5" (same perch as 7" Eagle)	#5A	\$39.95	each
7"	#7A	\$47.95	each
11"	#11A	\$94.95	each



Gold Eagle, 11" #11A

Gold Eagle, 7" #7A

Flag, Guidon and Lead Banner Poles

8' x 1" Wood Pole
Brass #81W



8' x 1 1/4" Wood Pole
Brass #84W



7' x 1" Wood Pole
Chrome #71WC



Two-Piece Polished Wood Poles

The natural beauty of a wood pole makes it an enduring choice for displaying colors with distinction. These carefully selected hardwood poles have a handsome metal screw joint and a rich polished oak finish on brass and dark oak on chrome. Wood poles should always be stored horizontally.



Brass Joint

Pole Size	Weight	Item #	Price
6' x 1"	1.75 lbs	#61W	\$62.95 each (\$5*)
7' x 1"	2.25 lbs	#71W	\$69.95 each (\$5*)
7' x 1 1/4"	2.50 lbs	#74W	\$74.95 each (\$5*)
8' x 1"	2.75 lbs	#81W	\$72.95 each (\$5*)
8' x 1 1/4"	3.50 lbs	#84W	\$82.95 each (\$5*)
9' x 1 1/4"	4.25 lbs	#94W	\$94.95 each (\$5*)
9' x 1 3/8"	5.00 lbs	#95W	\$105.95 each (\$5*)

Chrome Joint

Pole Size	Weight	Item #	Price
7'x1"	1.6 lb	71WC	\$102.95 each (\$5*)
7'x1 1/4"	3.1 lb	74WC	\$119.95 each (\$5*)
8'x1"	2.1 lb	81WC	\$107.95 each (\$5*)
8'x1 1/4"	3.5 lb	84WC	\$124.95 each (\$5*)
9'x1 1/4"	3.8 lb	94WC	\$136.95 each (\$5*)

Guidon Floor Saver

This black 1/2" rubber stopper saves gym and hardwood floors. Can be taped for added security.

#G1TIP Guidon Floor Saver
\$3.50 each



Military 7' Guidon Pole #G77C



Military 8' Guidon Pole #G87B



Military 9' Guidon Pole #G98C

Two-Piece Guidon Poles **BEST SELLER!**

Two-piece light ash pole with Army spear and bottom-tapered ferrule is a standard guidon staff made to military specifications. The sizes given are the total assembled height from top to bottom. These tapered poles measure 1-1/4" in diameter at widest point. The 7' pole is not a regulation size. Fits in Military Floor Stands (page 86) and Portable Floor stands (page 86) or floor stand adapter (page 86). Wood poles should always be stored horizontally.



- Military 7' Pole with Chrome Spear and ferrule. (7' is not regulation.)
- Military 8' Pole with Brass Spear and ferrule.
- Military 8' Pole with Chrome Spear and ferrule.
- Military 9' Pole with Chrome Spear and ferrule.
- Military 9' Pole with Brass Spear and ferrule.

- #G77C \$194.95 each (\$5*)
- #G87B \$194.95 each (\$5*)
- #G87C \$194.95 each (\$5*)
- #G98C \$216.95 each (\$5*)
- #G98B \$216.95 each (\$5*)

Assembling Two-Piece Poles

Before assembling two-piece poles, use a lubricant spray or gel on threads to avoid cross-threading precision screw joints.



Quality Mounting Pole Gold Aluminum #2216



Deluxe Mounting Pole Silver Aluminum #2238

Aluminum Lead Banner Poles

Each mounting is a two-piece aluminum crossbar. Poles have a solid brass precision-machined screw joint. Poles have either a shiny silver mil or bright gold finish.

For 6' Banners:

- Quality Mounting Pole, Gold 7' x 1", with golden acorn ends. #2215 \$99.95 each (\$5*)
- Deluxe Mounting Pole, Gold 7' x 1 1/8", with golden spear ends. #2233 \$193.75 each (\$5*)

For 8' Banners:

- Quality Mounting Pole, Gold, 9' x 1 1/4", with golden acorn ends. #2216 \$107.95 each (\$5*)
- Deluxe Mounting Pole, Gold, 9' x 1 1/8", with golden spear ends. #2237 \$225.95 each (\$5*)

* Due to increased shipping charges on all poles and banners, there is a shipping surcharge of \$5.00 each. The surcharge is shown in parentheses following the prices of items requiring the additional shipping fee.





7' x 1" Gold Parade Pole #71GE

8' x 1" Silver Parade Pole #81SE

Telescoping Gold Parade Pole #98TGE

Perfect-Fit Aluminum Poles

Two-Piece and Telescoping Styles
Precision-engineered to be incredibly lightweight and easy to handle, these beautiful poles are the choice of America's leading color guards and marching bands. Made from strong aluminum tubing with a rich gold anodized or bright silver mill finish, each two-piece pole has a base plug, a ring for attaching cord with tassels, and two adjustable rings to hold a flag tautly in place. The Telescoping Pole has an internal sleeve joint that forms a secure lock.



Gold	7'x1"	1.2 lb	71GE	\$84.95 each (\$5*)
Gold	7'x1 1/8"	1.7 lb	78GE	\$99.95 each (\$5*)
Gold	8'x1"	1.3 lb	81GE	\$87.95 each (\$5*)
Gold	8'x1 1/8"	1.9 lb	88GE	\$103.95 each (\$5*)
Gold	9'x1 1/8"	2.1 lb	98GE	\$105.95 each (\$5*)
Silver	7'x1"	1.2 lb	71SE	\$83.95 each (\$5*)
Silver	7'x1 1/8"	1.7 lb	78SE	\$99.95 each (\$5*)
Silver	8'x1"	1.3 lb	81SE	\$86.95 each (\$5*)
Silver	8'x1 1/8"	1.9 lb	88SE	\$103.95 each (\$5*)
Silver	9'x1 1/8"	2.1 lb	98SE	\$105.95 each (\$5*)
Telescoping Pole:				
Gold only	6' to 10'x 1 1/8"	1.4 lbs	98TGE	\$79.95 each (\$5*)

P Perfect-Fit Poles
Are threaded to precisely fit our Perfect-Fit Ornaments (see page 88).

* Due to increased shipping charges on all poles and banners, there is a shipping surcharge of \$5.00 each. The surcharge is shown in parentheses following the prices of items requiring the additional shipping fee.



Gold 6' Flag Pole #61G

Compact 6' Flag Pole with Spear

These durable aluminum poles are a great option when a shorter pole design is needed. Includes plastic base cap and short 3 1/2" spear. Bright gold finish.



Gold	6' x 1"	1.50 lbs	#61G	\$104.95 each
------	---------	----------	------	---------------

Quality Poles Let You Parade with Pride



9' x 1 1/4" Gold Parade Pole #94G

9' x 1 1/4" Silver Parade Pole #94S

Telescoping Gold Parade Pole #94TG

Traditional-Fit Aluminum Poles

Two-Piece Style Poles
Engineered for maximum performance and beauty, these poles are the choice of America's leading color guards and marching bands. Made from strong aluminum tubing with a rich gold or silver anodized finish. Each style has a shock absorbing rubber base plug and an adjustable band for attaching flag, cord and tassels.



	Pole Size	Weight		
Gold	7' x 1"	2.25 lbs	#71G	\$84.95 each (\$5*)
Gold	8' x 1"	2.75 lbs	#81G	\$93.95 each (\$5*)
Gold	8' x 1 1/4"	3.25 lbs	#84G	\$99.95 each (\$5*)
Gold	9' x 1 1/4"	3.75 lbs	#94G	\$112.95 each (\$5*)
Silver	7' x 1"	2.25 lbs	#71S	\$89.95 each (\$5*)
Silver	8' x 1"	2.75 lbs	#81S	\$96.95 each (\$5*)
Silver	8' x 1 1/4"	3.25 lbs	#84S	\$99.95 each (\$5*)
Silver	9' x 1 1/4"	3.75 lbs	#94S	\$112.95 each (\$5*)
Telescoping Pole:				
Gold Only	5' - 9' x 1 1/4"	2.00 lbs	#94TG	\$71.95 each (\$5*)

T Traditional-Fit Poles
Will fit our Traditional-Fit Ornaments. (see page 89).

Attaching cords and tassels

1. Insert folded end of cord and tassel up through bottom of screw eye.
2. Pass loose ends of cord and tassel through and over loop above screw eye.
3. Pull down gently until cord and tassel are snug against pole, then drape over the front of the flag.

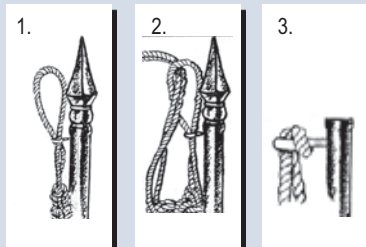

Perfect to Traditional Fit Adaptor



Our solid brass adaptor lets you install Traditional Fit ornaments (page 89) onto all sizes and styles of our Perfect Fit Poles.
2222E Perfect Fit Adaptor
\$22.95 each



See page 87 to see our Tassels and Cords

How to Order Custom Flags and Banners

Make an impression with beautiful custom flags and banners from Glendale. Flags and banners are easy to order and most can be created in 3-4 weeks time. To receive a firm quote on a custom flag or banner, please email the following specifications to: customwork@glendale.com along with a drawing or reference of your design.

1. What Item style are you looking for? (flag, banner, guidon, etc.)
2. Quantity of flags and banners you need.
3. Size: Both height and length.
4. Construction (single, single/reverse or double see below for more information)
5. Finish (pole sleeve or heading & grommet holes to attach to pole or guidon)
6. Method of manufacture (digitally printed or appliqued)
7. Background color(s) We can match most Pantone, hex or RGB colors.
8. Lettering that goes on the flag or banner (proper spelling, please!)
9. Lettering color(s) and Style (block or stylized)
10. Your emblem (Please provide artwork)
11. Emblem colors (if not depicted in artwork)
12. Fringe color(s) if you are adding fringe.

If you need help just call 1-800-653-5515 and ask for Custom Work.

IMPORTANT: If artwork must be redrawn (from a drawing, photograph, JPEG or other non-vector graphic), a \$50 per hour charge will apply.

Artwork can be emailed to: customwork@glendale.com



3' x 5' flag with digital print, grommets, and gold fringe.



20' x 21 3/4' guidon, digitally printed, pole sleeve.



This 8' x 3' banner can be appliqued or digitally printed.

Flag Terms to Know

Reverse Construction: Printing Front and Back



Single Construction: Printing Front only



Double Construction: Printing Front and Back

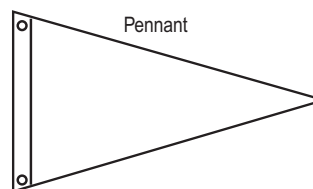

Pennant

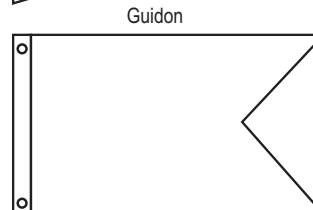

Guidon

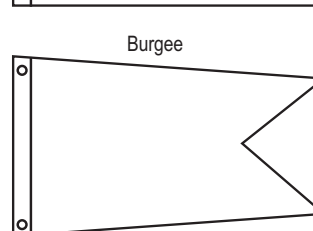

Burgee

Finish: Pole Sleeve

Finish: Heading and Grommet Holes



Fringe

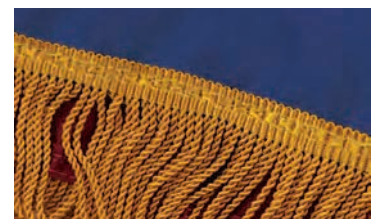

Lead Poles available for both 6" and 8" banners. See page 90





This 8' x 3' banner can be appliqued or digitally printed.



Customizable Air Force Guidon

Customizable Regulation Air Force Guidon. Single Reverse construction. Pole hem with leather tabs. Appliqued/ Embroidered Design on nylon
#AFGUIDON 20" x 27 3/4" \$339.00



3' x 5' flag with digital print, pole sleeve, and gold fringe.

Custom Patches and Flashes

Custom Patches

Embroidered patches with 100% or partial embroidery on a twill fabric can be made to your specifications. Price is determined by quantity, size, shape, amount of embroidery (number of stitches) number of colors, type of thread, and backing – PVC (sew on), glue (iron on), or hook and loop. Please send a detailed sketch (you can use a copying machine to blow the image to the desired 200%). Price quotation will be sent on inquiry. Allow 5-7 weeks for delivery after confirmation of order. Minimum order is 50 pieces; price break is at 200 and over. Designs may be emailed to customwork@glendale.com or faxed to 1-800-555-9269.



Glendale has 3 styles of berets. Turn to page 42 for styles, sizes and colors.

U.S. Flag Patches

Fully embroidered U.S. flag patches, 2" x 3" (within government specifications). All styles are sew-on unless noted otherwise with a Velcro® hook backing.

The reverse-star-field U.S. flag patch is worn on the right sleeve with the blue union (or star field) in the forward position of honor as if the flag were passing in review.



#1828

Red, white, blue with dark gold border.

#1828

\$1.95 each

#1828R

Red, white, blue with dark gold border, reverse star field. #1828R

\$1.95 each



#1829

Red, white, blue with white border.

#1829

\$1.95 each

#1829R

Red, white, blue with white border, reverse star field. #1829R

\$1.95 each



#1851

Red, white, blue with red border.

#1851

\$1.95 each

#1851R

Red, white, blue with red border, reverse star field. #1851R

\$1.95 each



#1856

Red, white, blue with light gold border.

#1856

\$1.70 each

#1856R

Red, white, blue with light gold border, Velcro®.

#1856V \$2.95 each

Red, white, blue with light gold border, reverse star field.

#1856R \$1.80 each

Red, white, blue with light gold border, reverse star field, Velcro®.

#1856RV \$3.50 each



#1858RV

ACU - Army Flag Patches

Red, white, blue with gold border, reverse star field.

#1857R

\$2.95 each

Red, white, blue with gold border, reverse star field, Velcro®.

#1857RV \$3.95 each

Foliage green/black, reverse star field, Velcro®.

#1858RV \$4.50 each

#1857R

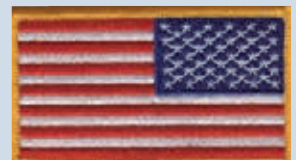

#1852

U.S. Waving Flag Patches

Fully embroidered U.S. flag patches.

Red, white, blue with gold border.

#1852

\$2.75 each

#1852R

Red, white, blue with gold border, reverse star field. #1852R

\$2.75 each



U.S. Flag Bunting

Decorative polyester/cotton bunting for showing star-spangled appreciation at special events.



4" x 6" flag pattern, 21' long. #0424 \$16.95 each

12" x 18" flag pattern, 25' long. #0426 \$32.95 each

Add patriotic spirit to any event or venue!



U.S. Spearhead Flags



Traditional hand-held flag often waved on parade routes. Poly/cotton flag in bright, permanent colors, securely stapled to black plastic staffs. Gilt spearheads.

4" x 6" with 10" black staff

#0411 \$0.79 each

8" x 12" with 24" black staff

#0412 \$1.89 each

12" x 18" with 30" black staff

#0413 \$2.69 each



4" x 6" U.S. Spearhead Flags #0411

More hand held US flags on page 51



State & Territorial Flags (See page 94-99 for U.S. Flags)

Unexcelled in beauty and craftsmanship and made to exacting specifications. Seals and designs are authentic and always in correct proportion to flag size. Emblems are dyed in fast, brilliant colors. (We cannot guarantee against fading or weathering.) **Indoor and Parade use flags** are made of lustrous 100% nylon. Finished with a flannel-lined pole hem with Velcro® tabs and golden yellow fringe. **Indoor flags** may also be ordered without fringe, if desired. **Outdoor display flags** are made of 100% heavyweight SolarMax nylon bunting (specially treated to minimize sun and chemical deterioration) and finished with strong canvas headings and large brass grommets. To order, indicate the flag number + state abbreviation. (For example #22035TX, for a Texas indoor flag size 3' x 5' or #22035UTX for the same without fringe.)



For Flags of the World Visit us online at www.paradestore.com

		OUTDOOR					INDOOR/PARADE			
		2' x 3'	3' x 5'	4' x 6'	5' x 8'	6' x 10'	—with fringe—		—without fringe—	
							3' x 5'	4' x 6'	3' x 5'	4' x 6'
AL	Alabama	#22123	#22135	#22146	#22158	#221610	#22035	#22046	#22035U	#22046U
AK	Alaska	\$29.95	\$39.95	\$59.95	\$89.95	\$169.95	\$89.95	\$119.95	\$69.95	\$99.95
AZ	Arizona	\$29.95	\$39.95	\$59.95	\$89.95	\$169.95	\$89.95	\$119.95	\$69.95	\$99.95
AR	Arkansas	\$29.95	\$39.95	\$59.95	\$89.95	\$169.95	\$89.95	\$119.95	\$69.95	\$99.95
CA	California	\$29.95	\$39.95	\$59.95	\$89.95	\$169.95	\$89.95	\$119.95	\$69.95	\$99.95
CO	Colorado	\$29.95	\$39.95	\$59.95	\$89.95	\$169.95	\$89.95	\$119.95	\$69.95	\$99.95
CT	Connecticut	\$29.95	\$39.95	\$59.95	\$89.95	\$169.95	\$89.95	\$119.95	\$69.95	\$99.95
DE	Delaware	\$29.95	\$39.95	\$59.95	\$89.95	\$169.95	\$89.95	\$119.95	\$69.95	\$99.95
FL	Florida	\$29.95	\$39.95	\$59.95	\$89.95	\$169.95	\$89.95	\$119.95	\$69.95	\$99.95
GA	Georgia	\$29.95	\$39.95	\$59.95	\$89.95	\$169.95	\$89.95	\$119.95	\$69.95	\$99.95
HI	Hawaii	\$29.95	\$39.95	\$59.95	\$89.95	\$169.95	\$89.95	\$119.95	\$69.95	\$99.95
ID	Idaho	\$29.95	\$39.95	\$59.95	\$89.95	\$169.95	\$89.95	\$119.95	\$69.95	\$99.95
IL	Illinois	\$29.95	\$39.95	\$59.95	\$89.95	\$169.95	\$89.95	\$119.95	\$69.95	\$99.95
IN	Indiana	\$29.95	\$39.95	\$59.95	\$89.95	\$169.95	\$89.95	\$119.95	\$69.95	\$99.95
IA	Iowa	\$29.95	\$39.95	\$59.95	\$89.95	\$169.95	\$89.95	\$119.95	\$69.95	\$99.95
KS	Kansas	\$29.95	\$39.95	\$59.95	\$89.95	\$169.95	\$89.95	\$99.95	\$69.95	\$119.95
KY	Kentucky	\$29.95	\$39.95	\$59.95	\$89.95	\$169.95	\$89.95	\$119.95	\$69.95	\$99.95
LA	Louisiana	\$29.95	\$39.95	\$59.95	\$89.95	\$169.95	\$89.95	\$119.95	\$69.95	\$99.95
ME	Maine	\$29.95	\$39.95	\$59.95	\$89.95	\$169.95	\$89.95	\$119.95	\$69.95	\$99.95
MD	Maryland	\$29.95	\$39.95	\$59.95	\$89.95	\$169.95	\$89.95	\$119.95	\$69.95	\$99.95
MA	Massachusetts	\$29.95	\$39.95	\$59.95	\$89.95	\$169.95	\$89.95	\$119.95	\$69.95	\$99.95
MI	Michigan	\$29.95	\$39.95	\$59.95	\$89.95	\$169.95	\$89.95	\$119.95	\$69.95	\$99.95
MN	Minnesota	\$29.95	\$39.95	\$59.95	\$89.95	\$169.95	\$89.95	\$119.95	\$69.95	\$99.95
MS	Mississippi	\$29.95	\$39.95	\$59.95	\$89.95	\$169.95	\$89.95	\$119.95	\$69.95	\$99.95
MO	Missouri	\$29.95	\$39.95	\$59.95	\$89.95	\$169.95	\$89.95	\$119.95	\$69.95	\$99.95
MT	Montana	\$29.95	\$39.95	\$59.95	\$89.95	\$169.95	\$89.95	\$119.95	\$69.95	\$99.95
NE	Nebraska	\$29.95	\$39.95	\$59.95	\$89.95	\$169.95	\$89.95	\$119.95	\$69.95	\$99.95
NV	Nevada	\$29.95	\$39.95	\$59.95	\$89.95	\$169.95	\$89.95	\$119.95	\$69.95	\$99.95
NH	New Hampshire	\$29.95	\$39.95	\$59.95	\$89.95	\$169.95	\$89.95	\$119.95	\$69.95	\$99.95
NJ	New Jersey	\$29.95	\$39.95	\$59.95	\$89.95	\$169.95	\$89.95	\$119.95	\$69.95	\$99.95
NM	New Mexico	\$29.95	\$39.95	\$59.95	\$89.95	\$169.95	\$89.95	\$119.95	\$69.95	\$99.95
NY	New York	\$29.95	\$39.95	\$59.95	\$89.95	\$169.95	\$89.95	\$119.95	\$69.95	\$99.95
NC	North Carolina	\$29.95	\$39.95	\$59.95	\$89.95	\$169.95	\$89.95	\$119.95	\$69.95	\$99.95
ND	North Dakota	\$29.95	\$39.95	\$59.95	\$89.95	\$169.95	\$89.95	\$119.95	\$69.95	\$99.95
OH	Ohio	\$29.95	\$39.95	\$59.95	\$89.95	\$169.95	\$89.95	\$119.95	\$69.95	\$99.95
OK	Oklahoma	\$29.95	\$39.95	\$59.95	\$89.95	\$169.95	\$89.95	\$119.95	\$69.95	\$99.95
OR	Oregon	\$44.95	\$89.95	\$129.95	\$149.95	\$239.95	\$139.95	\$189.95	\$119.95	\$159.95
PA	Pennsylvania	\$29.95	\$39.95	\$59.95	\$89.95	\$169.95	\$89.95	\$119.95	\$69.95	\$99.95
RI	Rhode Island	\$29.95	\$39.95	\$59.95	\$89.95	\$169.95	\$89.95	\$119.95	\$69.95	\$99.95
SC	South Carolina	\$29.95	\$39.95	\$59.95	\$89.95	\$169.95	\$89.95	\$119.95	\$69.95	\$99.95
SD	South Dakota	\$29.95	\$39.95	\$59.95	\$89.95	\$169.95	\$89.95	\$119.95	\$69.95	\$99.95
TN	Tennessee	\$29.95	\$39.95	\$59.95	\$89.95	\$169.95	\$89.95	\$119.95	\$69.95	\$99.95
TX	Texas	\$19.95	\$34.95	\$39.95	\$59.95	\$159.95	\$79.95	\$99.25	\$59.95	\$99.95
UT	Utah	\$29.95	\$39.95	\$59.95	\$89.95	\$169.95	\$89.95	\$119.95	\$69.95	\$99.95
VT	Vermont	\$29.95	\$39.95	\$59.95	\$89.95	\$169.95	\$89.95	\$119.95	\$69.95	\$99.95
VA	Virginia	\$29.95	\$39.95	\$59.95	\$89.95	\$169.95	\$89.95	\$119.95	\$69.95	\$99.95
WA	Washington	\$44.95	\$89.95	\$129.95	\$149.95	\$239.95	\$139.95	\$189.95	\$119.95	\$159.95
WV	West Virginia	\$29.95	\$39.95	\$59.95	\$89.95	\$169.95	\$89.95	\$119.95	\$69.95	\$99.95
WI	Wisconsin	\$29.95	\$39.95	\$59.95	\$89.95	\$169.95	\$89.95	\$119.95	\$69.95	\$99.95
WY	Wyoming	\$29.95	\$39.95	\$59.95	\$89.95	\$169.95	\$89.95	\$119.95	\$69.95	\$99.95
DC	Dist. of Columbia	\$29.95	\$39.95	\$59.95	\$89.95	\$169.95	\$89.95	\$119.95	\$69.95	\$99.95
GU	Guam	\$29.95	\$39.95	\$59.95	\$89.95	\$169.95	\$89.95	\$119.95	\$69.95	\$99.95
PR	Puerto Rico	\$29.95	\$39.95	\$59.95	\$89.95	\$169.95	\$89.95	\$119.95	\$69.95	\$99.95
VI	Virgin Islands	\$29.95	\$39.95	\$59.95	\$89.95	\$169.95	\$89.95	\$119.95	\$69.95	\$99.95
AS	American Samoa	\$29.95	\$39.95	\$59.95	\$89.95	\$169.95	\$89.95	\$119.95	\$69.95	\$99.95
SET	Complete Set	\$1,399.00	\$1,799.00	\$2,799.00	\$4,299.00	\$7,699.00	\$3,999.00	\$5,299.00	\$2,999.00	\$4,599.00

Complete sets include 50 state flags only.

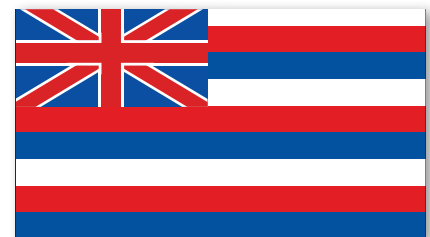
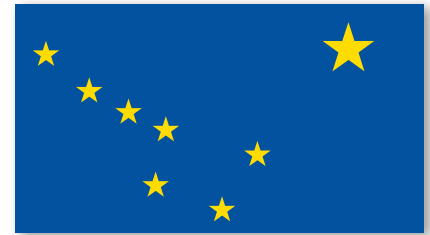



Army Flag, #7711



Air Force Flag, #7712



Air Force Departmental Flag, #7712AFD



Coast Guard Flag, #7715



Navy Flag, #7713



Space Force Flag, #7716SD

Armed Forces Flags



Nylon: This high-quality fabric exceeds stringent U.S. Government specifications. It is the most popular flag material and offers both durability and beauty. Outdoor flags have strong canvas headings and brass grommets. Indoor flags are

finished with flannel-lined pole hems, Velcro® tabs, and golden yellow rayon fringe. A single seal flag is correct on one side; reverse on the other. A double seal flag reads correctly on both sides. Double seal flags 4 1/3" x 5 1/2" and

larger will have the branch of service seal appliquéd onto the larger background. The lining of double sided flags is heat sensitive. Do not press.

	Army	Air Force	Navy	Marine Corps	Coast Guard	Space Force
Outdoor Nylon with canvas heading and grommets						
3' x 5', Single seal	#7711A3 \$49.95	#7712AF3 \$44.95	#7713N3 \$49.95	#7714M3 \$49.95	#7715C3 \$49.95	#7716SD3 \$54.95
4' x 6', Single seal	#7711A4 \$59.95	#7712AF4 \$64.95	#7713N4 \$69.95	#7714M4 \$74.95	#7715C4 \$59.95	#7716SD4 \$87.95

Outdoor polyester single seal flags available for all branches (except Space Force). Visit Glendale.com for pricing

Indoor & Parade Nylon w/ pole hem

3' x 5', Single seal w/ fringe	#7711A5 \$92.25	#7712AF5 \$92.25	7713N5 \$92.25	#7714M5 \$92.25	#7715C5 \$92.25	#7716SD5 \$92.25
3' x 5', Single seal w/o fringe	#7711A6 \$79.95	#7712AF6 \$79.95	#7713N6 \$74.95	#7714M6 \$74.95	#7715C6 \$83.95	#7716SD6 \$89.95
3' x 5', Double seal w/ fringe	#7711A7 \$199.95	#7712AF7 \$199.95	#7713N7 \$199.95	#7714M7 \$199.95	#7715C7 \$199.95	#7716SD7 \$199.95
4' x 6', Single seal w/ fringe	#7711A10 \$159.50	#7712AF10 \$154.50	#7713N10 \$154.50	#7714M10 \$154.50	#7715C10 \$159.50	#7716SD10 \$154.50
4' x 6', Single seal w/o fringe	#7711A11 \$133.95	#7712AF11 \$133.95	#7713N11 \$133.95	#7714M11 \$133.95	#7715C11 \$133.95	#7716SD11 \$144.95
4' x 6' Double seal w/ fringe	#7711A12 \$285.95	#7712AF12 \$285.95	#7713N12 \$285.95	#7714M12 \$285.95	#7715C12 \$285.95	#7716SD12 \$299.95

Indoor and Parade Armed Forces flags are sold in 4 1/3' X 5 1/2' size - Visit www.paradestore.com for current pricing.

Marine Corps Flag #7714



POW-MIA Flags, Patches and Pins are available at www.ParadeStore.com

Guarantee: We fully guarantee all merchandise against defects in material and workmanship.



Army National Guard Flag

3' x 5' Outdoor. Nylon with canvas heading and grommets. #7788 **\$56.95** each
 3' x 5' Indoor/Parade. Nylon with pole hem and fringe. #7789 **\$89.85** each



Air National Guard Flag

3' x 5' Outdoor. Nylon with canvas heading and grommets. #7786 **\$64.95** each
 3' x 5', Indoor/Parade. Nylon with pole hem and fringe. #7787 **\$99.95** each



Merchant Marine Flag

3' x 5' Outdoor. Nylon with canvas heading and grommets. #7800 **\$64.95** each

Custom Streamers: Honor and Award



Honor Unit #2305



Matching Date Streamer #2305D



Honor Unit with Distinction #2306



Matching Date Streamer #2306D



Distinguished Unit Date Streamer #2307

JROTC Honor Streamers

Honor Unit: 2 3/4" x 3', regulation, red and gold.	#2305	\$74.95 each
Matching Date Streamer (Specify dates.)	#2305D	\$74.95 each
Honor Unit with Distinction: 2 3/4" x 3', regulation, blue and gold.	#2306	\$74.95 each
Matching Date Streamer (Specify dates.)	#2306D	\$74.95 each
Distinguished Unit Date Streamer: 2 3/4" x 3', regulation, blue and gold. (Specify school year.)	#2307	\$74.95 each



15 Ring Holder #9330

Holders For Campaign Streamers

Silver-plated ring attachment for campaign streamers. (Designed to fit Army spear ornaments only, except 22GE and 22SE.)

15 rings - inside hole diameter is 1/2"; outside diameter is 2 3/8". #9330 **\$59.95** each
 18 rings (Army) - inside hole diameter is 5/8"; outside diameter is 3 3/8". #9331 **\$66.75** each



Custom Award Streamers

These streamers can be individually customized on a stock solid color ribbon – either 1 3/8" or 2 3/4" width – with a contrasting embroidery color, as specified by customer. Streamers are one sided only and each is finished with a metal grommet and stitched swallowtail. Made of Nylon material. Please submit text to be embroidered to customwork@glendale.com.

1 3/8" width: Available in black, brown, gray, white, kelly green, hunter green, light blue, navy blue, royal blue, red, orange, gold, yellow, maroon, and purple; stitch color of your choice:

1 3/8" x 24" (maximum 18 characters/spaces) #ST13824 **\$49.95** each
 1 3/8" x 36" (maximum 30 characters/spaces) #ST13836 **\$59.95** each

2 3/4" width: available in black, gold, navy blue, royal blue, purple, red, silver gray, and white; stitch color of your choice:

2 3/4" x 36" (maximum 30 characters/spaces) #ST23436 **\$79.95** each



Goldtone Award Ribbon Ring #9360G

Award Ribbon Ring

This metal ring fits on top of wood poles or 1" aluminum poles. Place disk under ornament.

6 rings: inside hole diameter is 7/8"; outside diameter is 3 1/2". Available in two finishes.

Silvertone #9360S **\$52.95** each
 Goldtone #9360G **\$66.95** each

Choosing Outdoor U.S. flags:

Glendale is proud to present a selection of outdoor flags designed to stand up to the varying weather conditions in which they fly. All styles are made with strong canvas heading and grommets for display on outdoor flag poles:

Polyester

The most durable flag fabric you can buy. Engineered for industrial, commercial and institutional use. (As with all flags, improper flag care, high winds, high temperatures and other environmental conditions that vary due to climate and location can reduce the fabric life.)

Nylon

Nylon is the most popular flag material. It is lightweight, holds dye well and can stand up to extreme conditions. Nylon flags can be recycled.

Cotton

An excellent quality flag made of extra-strength cotton weave bunting with rich colors that are resistant to sun and rain, making it suitable for a wide range of applications.

How long will a flag last?

The U.S. government generally expects a nylon or cotton bunting flag to last approximately 90 days, based on daily usage from sunrise to sunset — but not during periods of inclement weather. Tests have shown that in some cases a flag flown 24 hours a day will last only one-fourth as long as one flown during the daylight hours only. Regardless of how well it is constructed, a flag is, after all, only a piece of cloth and will sooner or later succumb to the elements. However, it has been well documented that reasonably good care can contribute greatly to longer life.



Government Spec U.S. Flag #4322

Government-Spec Outdoor Display U.S. Flags

Made to U.S. government specifications in accordance with U.S. Code, Title 4, in the official government size (1:1.9) hoist fly ratio. Choose from high-tenacity, industrial strength-70 denier lightweight nylon or 2-ply mercerized cotton bunting. Heavy canvas duck heading is constructed to government specs. Lock-stitched seams, material and color-matched thread. Stars are 3/4".



Nylon			Cotton		
2'4 7/16" x 4'6"	#4320	\$94.95 each	5' x 9'6"	#4328	\$164.95 each
3'6" x 6'7 3/4"	#4322	\$99.95 each			
5' x 9'6"	#4323	\$149.95 each			

Polyester Outdoor Display U.S. Flags

3' x 5'	#2710	\$39.95 each	10' x 19'	#2765	\$397.95 each
4' x 6'	#2720	\$77.95 each	12' x 18'	#2770	\$379.95 each
5' x 8'	#2730	\$84.95 each	15' x 25'	#2780	\$729.95 each
5' x 9 1/2' casket size	#2735	\$129.95 each	20' x 30'	#2790	\$999.95 each
6' x 10'	#2740	\$122.95 each	20' x 38'	#2800	\$1399.00 each
8' x 12'	#2750	\$309.95 each	30' x 50'	#2827	\$2699.00 each
10' x 15'	#2751	\$321.95 each	30' x 60'	#2830	\$2999.00 each



Nylon Outdoor Display U.S. Flags

2' x 3'	#0242	\$39.95 each	8' x 12'	#0232	\$239.95 each
2 1/2' x 4'	#0244	\$47.95 each	10' x 15'	#0234	\$226.95 each
3' x 5'	#0246	\$25.95 each	10' x 19'	#0235	\$377.95 each
4' x 6'	#0222	\$51.95 each	12' x 18'	#0236	\$324.95 each
4 1/3' x 5 1/2'	#0224	\$84.95 each	15' x 25'	#0238	\$609.95 each
5' x 8'	#0227	\$75.95 each	20' x 30'	#0240	\$869.95 each
5' x 9 1/2' casket size	#0228	\$119.95 each	20' x 38'	#0241	\$1199.00 each
6' x 10'	#0230	\$135.95 each	30' x 50'	#0243	\$1799.00 each
			30' x 60'	#0245	\$2499.00 each



Cotton Outdoor Display U.S. Flags

2' x 3'	#2754	\$41.25 each	5' x 9 1/2' casket size	#2759	\$141.95 each
3' x 5'	#2755	\$49.95 each			
4' x 6'	#2756	\$69.95 each	6' x 10'	#2758	\$169.95 each
5' x 8'	#2757	\$109.95 each	8' x 12'	#2762	\$349.95 each



Appropriate flag sizes for outdoor poles:

Length of flag should be approximately 1/4 of the height of the flagpole:

20' pole - 3' x 5' flag.

25' pole - 4' x 6' flag.

40' pole - 6' x 10' flag.

A second flag flown under the U.S. flag should be one size smaller than the U.S. flag.

Our Solar Lighted Flag needs no plugs, cords or power to shine bright!



Solar Lighted US Flag Unit #0417

Solar Lighted US Flag Unit



Add beauty and patriotic spirit to walkways, gardens, decks, and gravesites. Solar light charges itself during the day and shines on the flag at night. Flag made in USA. Light imported from China. 12"x18" Flag on a 30" wooden staff.

Solar Lighted US Flag Unit #0417 \$6.95 each

Glendale carries a wide variety of cotton flags, including cotton casket flags. If you are looking for a specific cotton flag, give us a call.



Memorial Flag Cases are shown on page 52.



Casket bands to hold a flag securely are shown on page 52.

Choosing Indoor & Parade U.S. flags

Nylon

Very durable. Made of high quality nylon that exceeds stringent U.S. Government specifications. High-gloss, densely embroidered stars. Lock-stitched, hand-sewn stripes and hems. Finished with flannel-lined pole hems, Velcro® tabs and, if requested, golden yellow rayon fringe.

Bemberg Rayon

The finest, most luxurious flag fabric available. Woven of heavy Bemberg rayon, this flag combines a beautiful appearance with superior form retention. A particular favorite of the federal government. Features large embroidered rayon stars. Finished with a flannel-lined pole hem and Velcro® tab. Available with golden yellow rayon fringe. Note: this fabric may stain if it gets wet.

Recommended sizes

Flag Size	Pole Size	Tassels & Cord
2' x 3'	7'	3" & 5'
3' x 5'	8'	5" & 9'
4' x 6'	9'	5" & 9" or 6" & 9'

Flag Spreader

The center part of this spreader snaps around an indoor pole, and the ends clip to the sides or to both corners at the bottom edge of the flag – holding an indoor flag open, so more of it can be seen when it's draped.

Flag Spreader #2227 **\$23.75** each



Save when you buy a Mounted US Flag Set!

American Made with Pride

U.S. Flags: Indoor & Parade Use, Nylon

2' x 3' fringed	#0210	\$79.75 each
2' x 3' unfringed	#0219	\$64.95 each
3' x 4' fringed	#0229	\$144.25 each
3' x 4' unfringed	#0223	\$129.95 each
3' x 5' fringed	#0215	\$88.75 each
3' x 5' unfringed	#0211	\$75.25 each
4' x 6' fringed	#0216	\$133.95 each
4' x 6' unfringed	#0212	\$119.95 each
4 1/3' x 5 1/2' fringed	#0217	\$217.95 each
4 1/3' x 5 1/2' unfringed	#0213	\$179.95 each
5' x 8' fringed	#0218	\$207.95 each
5' x 8' unfringed	#0214	\$179.95 each



No Fringe



Beautifully embroidered stars that shine brightly against the rich blue background.

U.S. Flags: Indoor & Parade Use, Rayon

3' x 5' fringed	#2270	\$349.95 each
3' x 5' unfringed	#2230	\$331.95 each
4' x 6' fringed	#2280	\$461.95 each
4' x 6' unfringed	#2240	\$439.95 each
4 1/3' x 5 1/2' fringed	#2290	\$475.95 each
4 1/3' x 5 1/2' unfringed	#2250	\$465.95 each

Mounted U.S. Flag Sets (includes stand)

This pre-assembled set includes everything you need to proudly fly America's colors, right out of the box. You save and pay no weight surcharge. The 3' x 5' set is shipped in one oversized carton; the 4' x 6' set, in two. (UPS Ground or Parcel Post delivery only). Sorry, no substitutions or partial returns.

3' x 5' mounted flag set. Includes: 3' x 5' fringed nylon flag (#0215), 8' x 1 1/4" wood pole with dark oak finish (#84W), brass-plated eagle with 7" wing span (#7A), 5" golden tassels with 9' cord (#118) and 8 lb. gold Liberty Floor Stand (#LG8) **\$299.95** each #35US84W

4' x 6' mounted flag set. Includes 4' x 6' fringed nylon flag (#0216), 9' x 1 1/4" wood pole with dark oak finish (#94W), brass-plated eagle with 7" wing span (#7A), 6" golden tassels with 9' cord (#119) and 8 lb. gold Liberty Floor Stand (#LG8) **\$379.95** each #46US94W

How to mount an indoor flag:

On aluminum poles – Pull out the Velcro® tabs inside the top and bottom of the pole hem. Loosen the set and eye screws of the aluminum ring, slide it down the pole, and position it where it will hold the bottom tab of the flag. Carefully slide top of pole up through the flag's pole hem. Attach the ornament to the top of the pole. Slip tab button holes over the eye screws of both the ornament and ring. Adjust aluminum ring so that pole hem is taut and tighten screws against pole. Instead of attaching tabs to the eye screws, Velcro® tabs can be more permanently fixed directly to the pole. Remove the adhesive backings, position the flag and press the sticky sides of the tabs to the flag pole.

On wood poles – No bottom ring is required. Top Velcro® tab may be attached to the eye screw of the ornament or the adhesive side may be affixed directly to the flag pole.



Mounted U.S. Flag Set

Look inside!

Quick Index

See full index on page 79

Arc Pins	69
Ascots	44
Belts	33-35
Berets	42-43
Bib Scarves • Leader Loops	44
Books • DVDs	14
Cheater Bars	39
Custom Flags/Banners/Patches	92-93
DrillAmerica® Rifles	4-10
Fire / Rescue	50
Flag Carriers	82-84
Flag Covers and Cases	85
Flag Pole Floor Stands	86-87
Flag Pole Ornaments	88-89
Flag Poles	90-91
Flags	94-99
Garment & Gear Bags	46-47
Gloves	20-22
Hat Carriers	66-67
MarchOn® Tee Shirts	online
Medals and Drapes	74-78
Memorial	51-55
Nameplates	41
Ordering Information	80-81
Parade Helmets	45
Parade Rifles	4-10, 14
Pins: Hat • Collar • Lapel 51, 60-63, 68-69	
Police Hats	48
PT Clothing and Tee Shirts	32
Ribbon Attachments	56, 70
Ribbon Mounts	70-71
Ribbon Slides	56, 61-62, 72-73, 75
Rifle and Pistol Accessories	11-15, 34-37
ROTC & JROTC	56-62
Saber & Sword Accessories	19
Sabers & Swords	16-17
Shoe & Boot Accessories	38-39
Shoes	39
Shoulder Cords	23-31
Uniform Accessories	40-41
U.S. Air Force	65-67
U.S. Army	64
U.S. Marine Corps	63

Swords and Sabers

We carry world-famous Weyersberg, Kirschbaum & Co. (WKC) Swords and Sabers. Turn to page 16 to learn more about these extraordinary weapons.

- Air Force Honor Guard Sword,
- Regulation Army Officer Saber
- West Point Military Style Sword

- Navy Officer Sword
- Coast Guard Officer Sword
- Marine Corps NCO Sword



Engrave your sword for just \$25, see page 16 for details.

DrillAmerica® makes the finest drill rifles you can buy. Designed for precision and balance to the exacting specification of world class drillers.

Turn to pages 4-10 to see all 5 models.



DrillAmerica 1903 Springfield Rifle®
Black with Chrome Metal #DA1903BKC
Available in 4 additional color options. Turn to page 4 to learn more



NEW! 9" Tactical Boots
#3475S \$109.95 pair — turn to page 39



Cold hands?
Try fleece lined gloves!

Warm Fleece-Lined Gloves

You'll appreciate the warmth of the light fleece lining inside these breathable, comfortable top quality gloves. Also available in long to cover wrists. Turn to page 21 to learn more.

Regular 9" S-M or L-XL
Plain palm #1075 \$4.75 pair

Order online www.paradestore.com • Phone 1-800-653-5515 (8-5 CST Mon-Fri) • Fax 1-800-555-9269